

INSTRUCTION

Handbook
ENG



use
installation
adjustment
maintenance

CITY TOP

25 K

35 K



Caldaie • Scaldabagni • Sistemi Solari • Climatizzatori

Table of Content

Safety warnings	3	Condense drain	20
Safety warnings symbols legend	4	Heating system filling and pressuring	20
References to Laws and Norms	4	Gas connection	21
Personnel in charge of installation	4	Electrical connections	22
Installation, use and maintenance	4	Flue systems	23
User warnings	5	General indications	23
Important	5	Sizing C ₆₃ systems	24
First starting up and Use	5	Examples of installation of intake and outlet ducts	25
Installation, first starting up, maintenance and servicing	6	Sizing the flue system	26
Appliance booklet or central plant booklet	6	Flue system length	26
Combustion checking	6	How to use the tables	26
Boiler operation and servicing	6	System length tables	27
		Allowed flue types	28
User guide	7		
The front control panel	7	Adjustment and Maintenance	29
Commands on the lower side	8	First starting up	29
Commands outside the boiler	8	Maintenance operations	30
Typical use	9	Access to the inside of the boiler	31
Preliminary operations	9	Venting the primary exchanger	32
Boiler activation	9	Combustion group cleaning and check	32
Temperature adjustment	10	PCB parameters settings (technician menu)	33
The "plus" function (DHW pre-heating)	10	Main boiler parameters (PC)	34
How to set the desired "plus" level	10	Combustion test	37
How to enable or disable the "plus" function	11	CH Power Input adjustment tables	38
INFO menu	11	Max heating power adjustment	39
INFO for user	11	Combustion calibration	40
INFO for the technician	11	Accessing the main board	40
Incidental malfunctioning	12	Main board replacement	41
The burner doesn't turn on	12	Board configuration codes	41
Shortage of domestic hot water production	12	Gas conversion	41
Boiler inactivity	12	Draining the heating system	42
Safety shut off	12	Pump settings	42
Stand-by mode with anti-frost & anti-locking function	13	Alarms - boiler block	42
"Ambient Anti-Frost" Function	14	Warnings for servicing	49
		ErP Data - EU 813/2013	50
		Product fiche - EU 811/2013	50
		Technical data	51
		Boiler internal components	53
		Electrical diagram	54
		Hydraulic diagram	55
Installation	14		
Law and regulation prescriptions for the installer	14	Addendum	56
Dimensions and connections	15	Outdoor Sensor Kit	56
Pump capacity diagram	15	Installation and setting	56
Warnings for the installation of optional kits or special systems	16	Outdoor Sensor kit and Remote Control	56
Floor heating system	16	Remote Control Kit	57
Specifications for intake air	16	Appliance disposal	57
Domestic water supply characteristics	16	Modulating circulating pump - details	58
Protection against freezing	17	Status indicator	58
Outdoor installation in a partially protected place	17	Circulating pump rotor unlocking	58
Positioning and fastening	18		
Hydraulic system (DHW and heating)	19		
Advices and suggestions to avoid vibrations and noises in the system	19		
Cleaning and preservation of the systems	19		
Heating system	19		







This instructions manual is an essential and complementary part of the product and it is supplied together with the boiler.



Carefully read the manual, achieving all important information for a safe installation, use and servicing.

- ▶ **Carefully keep the manual**, together with the documentation of all the accessories of the boiler and of the system, for any further consultation you may need.
- ▶ **The installation** must be carried out by a qualified technician, in accordance with manufacturer instructions and with the relevant requirements of the current issue.
- ▶ **Carbon monoxide (CO) danger:** the CO is a no-smelling and no-colour gas. When a forced draught boiler with air intake from the room (appliance type B₂) is installed, permanent ventilation of the installation room is mandatory and extremely important. Ventilation must be made and sized in compliance with Laws and Rules in force. Whatever manumission, closing or neutralization of the permanent ventilation could lead to very serious consequences to people in the rooms, as intoxication by CO, permanent damage and death. Besides, the CO and O₂ mix can be explosive.
- ▶ A **qualified technician** is a person with a specific technical competence in the field of the heating appliances for domestic use and domestic hot water production, in compliance with Laws and Rules in force.
- ▶ The **operations that the user can do** are only and exclusively the ones contained in the "USER GUIDE" section.
- ▶ The manufacturer has no contractual and extra-contractual responsibility for any damage arising from wrong installation, wrong use and non-observance of current laws and instructions given by the manufacturer himself.
- ▶ **Important:** this gas boiler is used to heat the water at a temperature lower than the boiling one, at atmospheric pressure; it must be connected to an heating system and/or to a domestic hot water system, in accordance with its features and power.
- ▶ Packing items (cartons, nails, plastic bags and so on) **must not be left within children easy reach**, as they are potentially dangerous.
- ▶ **Before any cleaning or servicing operation**, disconnect the boiler from the mains electrical supply by means of the main electrical switch and stop the gas supply by means of the suitable cock.
- ▶ **In case of fault** and/or bad operation of the appliance, disconnect it immediately and do not try to repair it by yourselves.
- ▶ **Boiler servicing and repair** must be carried out exclusively by qualified technicians, which will use original spare parts. Strictly observe the above requirement, avoiding any risk of compromising the appliance safety.
- ▶ **If the appliance should be definitively dismissed**, remove or cut off any potential dangerous item. *Dispose of it according to the regulations in force (page 57).*
- ▶ **When transferring the appliance** (e.g. leaving it installed after a removal or a sale of the building), make always sure that the instructions manual is close to the boiler for the future use of new owners and/or installers.
- ▶ This appliance **must be used for its clearly recommended utilization only**. Any other utilization must be considered dangerous and incorrect.
- ▶ It is strictly forbidden to use the appliance **for different purposes** than the specified ones.
- ▶ This appliance must be **installed exclusively to wall**.

Safety warnings symbols legend

 Generic safety warning	 Electrical danger (fulguration)	 Physical danger (personal damage)
 Thermal danger (burns)	 General warning or advice to avoid material damage or to achieve improvements	

References to Laws and Norms

All references to laws and laws contained in this handbook, as well as all installation, maintenance and use prescriptions and the relevant pictures, are relevant to European and/or Italian regulation.

All laws and norms in force in the territory where the installation takes place prevail on the indications contained in this handbook, that are inconsistent with them.

 All the **references to norms and national laws** mentioned in this handbook are indicative as laws and norms are subject to issues and integrations by the authorities in charge. **Also comply to eventual local norms and laws** (not mentioned in this handbook) in force in the territory where the installation takes place.

Personnel in charge of installation

 **Always comply with national and/or local regulation about WORK SAFETY of Personnel in charge of installation.**

 Always proceed with caution when handling the boiler and carrying out installation/maintenance work as metal parts may cause injuries such as cuts and abrasions. **Wear personal protection devices** (especially gloves) while doing the above mentioned operations

Installation, use and maintenance

 **Always comply with national and/or local regulation about BOILER INSTALLATION.**

User warnings

Important



In case of gas smell:

- 1 - **do not press electrical switches, use the telephone or other objects that can provoke sparks;**
- 2 - **open immediately the windows and the doors in order to cleanse the room air;**
- 3 - **close the gas supply taps;**
- 4 - **call a qualified technician.**



Do not obstruct the ventilation openings of the gas boiler room, in order to avoid possible dangerous situations as the creation of poisonous or explosive mixtures.

First starting up and Use



The first starting up and the maintenance of the boiler must be performed by a professionally qualified staff (for example the installer or the Service Centres authorized by ITALTHERM)

The latter will check that:

- ▶ the label technical data of the gas boiler correspond to those of the gas available;
- ▶ the main burner regulation is compatible with the gas boiler output;
- ▶ the chimney works correctly, expelling the combustion products;
- ▶ the air supply and the combustion products evacuation work correctly, in accordance with the requirements in force;
- ▶ the conditions for a correct ventilation are guaranteed, also when the gas boiler is located inside a closed space (with suitable characteristics).



This boiler is designed and prepared to be supplied with Natural Gas G20 (Methane). It can be set, just by means of electronic settings, but always by a qualified technician, to operate with Commercial Propane G31 or Air/Propane G230. It must never be used with butane gas G30 (that can be present, pure or mixed with Propane G31, in the portable gas bottles for cookers).



The User must not touch sealed items nor break the seals. Only specialized technicians and the official technical service can break the seals of sealed items.



The boiler is fitted with safety devices that block operation the case of problems with the boiler or related systems. These devices must never be disabled: if a device intervenes frequently, have a qualified technician located the cause, even in systems to which the boiler is connected, and in the flue intake/outlet system that must be efficient and made according to the laws in force (see examples in paragraph "Flue systems" on page 23). If a boiler component has failed, you must only use original replacement parts



When the boiler is off for a long period see the Paragraph "Boiler inactivity" on page 12 for the necessary precautions about the electrical supply, the gas supply and the protection against freezing.



Do not touch the heated surfaces of the boiler, as the doors, the flue, the chimney pipe, etc., also after the boiler operation because, for a certain time, these surfaces are overheated. **Any contact with them can cause dangerous scalds.** It is then forbidden to let children or inexperienced people be close to the boiler, during its operation.

- ▶ Do not expose the wall hung gas boiler to water or other liquids sprinklings, or to vapours directly coming from gas cookers/hobs.
- ▶ Do not obstruct the air intake or flue outlet terminals, even momentarily or partially.
- ▶ Do not put any object on the gas boiler and don't leave any flammable liquid or solid materials, (e.g. paper, clothes, plastic, polystyrene) in its proximity.
- ▶ This appliance is not intended for use by persons (including children) with reduced physical, sensory or mental capabilities, or lack of experience and knowledge, unless they have been given supervision or instruction concerning use of the appliance by a person responsible for their safety. Children should be supervised to ensure that they do not play with the appliance.
- ▶ If the gas boiler is going to be definitively unused, call a qualified technician to carry out all required operations, checking in particular disconnection of gas, water and electrical supplies.
- ▶ **Only for those models that draw directly from the installation room** (type B appliances installed in-door): the installation of aspirators, fireplaces or similar appliances in the room where the type B appliance is installed (and in adjacent rooms in case of indirect ventilation) is prohibited except in cases foreseen by rules in force and anyway the installation must be made in compliance with all specific safety measures mentioned in the rules and laws in force, even in case of modifications or additions.

Installation, first starting up, maintenance and servicing

All operations for installation, first starting up, maintenance, servicing and gas conversion **must be carried out by qualified technicians**, in accordance with the Norms and Laws in force.

Maintenance operations must be carried out in compliance with the manufacturer prescriptions, and in compliance with the laws and rules presently in force for what is not mentioned in this handbook; we advice to perform them at least once a year to maintain the boiler's performance.

Appliance booklet or central plant booklet

All appliances must have an appliance booklet (for outputs less or equal 35 kW) or a central plant booklet (for outputs more than 35 kW). All maintenance and servicing operations and combustion checks must be written on the booklet, together with the name of the person responsible for servicing.

Combustion checking

Combustion checking consists of a control of the boiler efficiency. Boilers that, after the checking, will have efficiency rates lower than the ones required and not changeable with suitable adjustments (that must be performed by qualified technicians), must be replaced.

Boiler operation and servicing

The user (owner or tenant of the flat where the boiler is installed) or the administrator of the block of flats (in case of a central heating system) are responsible for the appliance operation and servicing; they can both transfer the responsibility of the servicing and eventually of the operation to another person, which must be a qualified technician as indicated by the Laws. Even if the user or the administrator decide to assume personally this responsibility, ordinary servicing of the warm air heater and combustion checks must be anyway carried out by a qualified technician



The front control panel

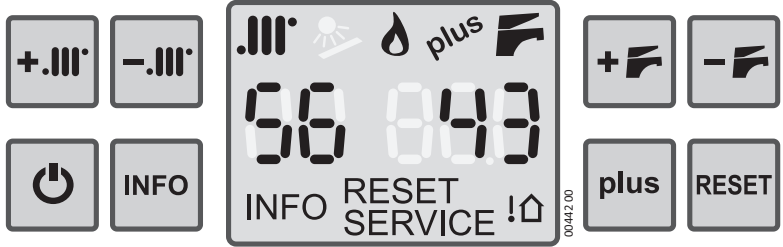

Pushbuttons



Stand-by / Functioning mode

At every press, the boiler cyclically switches its mode from OFF to summer **F** or winter **.III** + **F** mode.



CH setting



To set the CH system temperature. If the Outdoor Sensor Kit was installed, see also "Outdoor Sensor Kit" on page 56.



DHW setting



To set the DHW temperature.



Press to reset the boiler in case of breakdown.

See further details in "Alarms - boiler block" on page 42.



It manually sets the activation, inactivation, and the level of the DHW pre-heating mode. See "The "plus" function (DHW pre-heating)" on page 10 for details.



It displays additional boiler information. See "INFO menu" on page 11 for details.

Display - symbols enabled in this model and their description



CH – winter mode indication

If flashing, it means that the boiler is functioning in CH mode. See also the remark in the description of symbol **F**.



Burner ON

It indicates the presence of the flame in the burner.



DHW mode indication

If flashing, it means that the boiler is functioning to produce hot water.



If both **.III** and **F** symbols flash at the same time, a Technician-reserved function has been activated. In this case, turn immediately the boiler off - and then turn it on again - by means of the button

56

Two digit display under the symbol .III

Normally, it displays the **CH flow** temperature, i.e the temperature of the liquid on boiler's outlet that is sent to the CH system.

88

During the CH temperature setting (by pressing the buttons **+ .III** and **- .III**), it shows the **temperature value changing**; in case of **alarm** it displays "E"; during the **setting (reserved to the Technician)** it displays the chosen **parameter ID number** (see "PCB parameters settings (technician menu)" on page 33).

843

Three digit display under the symbol F

Normally, it displays the temperature of the hot water on boiler's outlet. When the boiler is in stand-by mode, it displays **OFF** .

0FF

During the DHW temperature setting (by pressing the buttons **+ F** and **- F**), it shows the **temperature value changing**; in case of **alarm** it displays the **ID number** of the alarm (see "Alarms - boiler block" on page 42); during the **setting (reserved to the Technician)** it displays the **value** of the chosen **parameter**.

RESET

It appears when the boiler is locked or anyway is present an error that the user could manage. See "Alarms - boiler block" on page 42 to identify the problem and the relevant actions to be carried out.

SERVICE

It appears when the boiler has detected an error (mainly a fault) that has to be managed by the Technician. The User can anyway see "Alarms - boiler block" on page 42 to get information about and the eventual actions to be carried out.



It informs that the outdoor probe (accessories) is installed.

*Note: In this case the CH system temperature is automatically set and so the use of buttons **+ .III** and **- .III** is different from the standard way: for deeper details rely on kit instruction and see "Outdoor Sensor Kit" on page 56.*

plus

It means the function is ON. It flashes when the boiler is working for that. See "The "plus" function (DHW pre-heating)" on page 10 for details.

INFO

It means that additional information about boiler work are displayed. See "INFO menu" on page 11 for details.

Commands on the lower side

- 1 System pressure gauge
- 2 Screw for manual system filling
- 3 GAS cock

Commands outside the boiler

Externally the boiler, suitably positioned in the building (generally by the installer or by the electrician), two devices that the user should access to, are present. The presence and the characteristics of these devices are prescribed by the regulation in force.

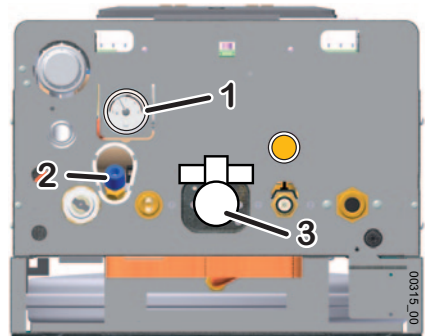

Two-pole switch: it is located usually close to the boiler and it's for electrically insulating the boiler itself from the domestic mains power supply network. It is useful to disconnect the boiler from the electrical supply, e.g. during inactivity periods (see "Safety shut off" on page 12) or in some cases of alarm (see "Alarms - boiler block" on page 42).

Room thermostat: it commands electrically the boiler to activate or deactivate the heating system, in order to keep the room temperature (detected by a sensor) within a value set by the user, Regulation in force prescribe its positioning, the temperature limits within the user can adjust it and the periods of heating.

Remark: an optional, original Remote Control kit is available (see "Remote Control Kit" on page 57 for information) or a cutting-edge chronothermostat kit featuring weekly programming of various temperature levels and other special functions. Also **wireless** and **GSM controlled** versions are available.











Typical use

Preliminary operations

- ▶ Be sure the gas cock **3** is opened.
- ▶ Be sure the boiler is electrically powered and set in **OFF**: only **OFF** has to be displayed on the screen.
- ▶ Make sure, by the gauge **1** that the **cold-system temperature is always within 0.5 and 1.5 Bar (optimal: 1+1.5 Bar)**. The boiler is equipped with an automatic system to control and restore the system pressure, so it should always be correct (otherwise an error code will show, see "Alarms - boiler block" on page 42). *The filling cock with screw command 2 is foreseen for the first filling, or for momentary use in case of failure to the automatic system.*

 The system pressure raises with the temperature: a too high initial cold-system pressure could lead to **water drain from the 3 Bar safety valve** after the system heating-up.

Boiler activation









- ▶ Press the button  :
 - once to set the boiler in summer mode only (DHW only). Summer mode is recognizable by the only symbol presence  on the display and not by the symbol presence  ;
 - pressing twice to set the boiler in winter mode for making the boiler working both for CH and DHW. Winter mode is recognizable by the both symbols presence  and  on the display;
 - at each press of the button  , the boiler cyclically switches from **OFF** to summer  and to winter  +  mode.
- ▶ Opening a DHW tap, the burner fires up, and after a little time (that also depends on the characteristics of the DHW system downstream the boiler) DHW is available. To have shorter waiting times, use the function **plus** (see "The "plus" function (DHW pre-heating)" on page 10).
- ▶ On winter mode  +  , when room thermostat demands for heating, the burner fires up and thanks to the water flow the heating get transferred . In case of contemporary demand of both DHW and CH, the DHW demand has the priority till the demand finish. Usually, as DHW does not last for long, this priority does not affect the CH efficiency in the system.

Temperature adjustment

Note: correct adjustment leads to creating the conditions for energy saving.

Note: if a Low Temperature Kit or an Outdoor Probe Kit are installed, refer to the relevant documentation for what concerns the heating system temperature adjustment.

Note: don't make confusion between the heating system temperature  here described, with the temperature of the room set on the Room Thermostat.

- ▶ **Heating system adjustment:** by using the buttons  and , the setting of the heating system temperature is made (the value, during the adjustment, is shown on the display under the symbol ). Generally, in the deep cold season and/or with poor building thermal insulation (or if you notice that the burner stays on for a long time, but the room temperature rises too slowly) prefer higher settings. On the contrary, if you notice that the room temperature exceeds too much, for thermal inertia, the value set on the room temperature, it's appropriate to decrease the system temperature. **When the optional Outdoor Temperature Probe Kit is installed, the system temperature is automatically managed and the use of the buttons  and  is different: for details, see also "Outdoor Sensor Kit" on page 56.**
- ▶ **Domestic hot water adjustment:** the buttons  and  set the temperature of the hot water produced by the boiler (the value, during the adjustment, is shown on the display under the symbol ). On this type of boiler, we suggest to set it in such a way to have a comfortable hot water temperature by drawing only hot water or eventually by mixing it with a little cold water. Avoid maximum values if not strictly needed, that will force to mix the hot water with bigger quantities of cold water. Consider that, because of the dispersions along the pipings, a certain time is needed to have a stable water temperature on the cock outlet, therefore the best temperature evaluation is achieved during a bath or a shower.

The "plus" function (DHW pre-heating)





A special feature of this boiler is the **plus** function whose advantage is to keep the sanitary water always warmed in order to reduce the DHW time delivery when required. This allows to shortcut the waiting time and the water waste.

Thanks to the insulated material the DHW exchanger is wrapped with, the boiler **reduces** the heating losses and so gets an **optimized consumption of gas in comparison with the boilers that don't feature this function** (especially during brief and frequent DHW withdrawals).

It is possible:

- to set the pre-heating mode on three different levels;
- enable or disable the **plus** function;

How to set the desired "plus" level

- ▶ Put the boiler in **OFF** mode, by pressing the button .
- ▶ press the button **plus** for at least 3 seconds;
- ▶ on the left of the display, the sign **11/ts** appears cyclically while on the right appears a number from 01 to 03 representing the **plus** pre-heating level: (01=normal; 02=high, 03=maximum);
- ▶ to change the **plus** level, use the buttons  and ; **to store, press the button RESET for 2 seconds, then **; to quit without saving, press just  or wait 20 seconds.

 If hard water is present, it's recommended to use the level no. 1. The level 3 can be used only if the water has low scale content or if it's processed this way.

How to enable or disable the "plus" function

- ▶ With the boiler in winter or summer mode (not in OFF mode), press the button **plus** to enable or disable the pre-heating function **plus**. When it's activated, the symbol **plus** appears on the display.

INFO menu

INFO for user

It is possible to get information displayed, about the boiler functioning and the values detected by its sensors. Usually they are useful for the Technician only. Anyway, even the user can look at them without affecting the good working of the boiler.

- ▶ With the boiler in winter or summer mode (no OFF mode), press the button **INFO** for at least 5 seconds;
- ▶ the display shows the symbol **INFO**, a **sign on the left** that identifies the data and the relevant **value on the right**. To navigate through the available data, use the buttons **+ .III'** and **- .III'** :
 - **t1**: outdoor temperature (if the outdoor temperature sensor is installed)
 - **t2**: heating *system return* temperature (we remind that, during normal work, the *system flow*, temperature is shown, on the left of the display)
 - **t3**: solar collector temperature (if the relevant, compatible system is present)
 - **t4**: solar storage tank temperature (if the relevant, compatible system is present)
 - **P**: heating system pressure (in models equipped with a specific sensor)
 - **Fu**: indication about the current working status. The meaning of the value on the right is:

0	no request (boiler idle)	4	anti-freeze function on heating system
1	in heating mode upon request of the main or sole Room Thermostat (TA) or Remote Control	5	DHW request
2	in heating mode upon request of the secondary Room Thermostat (TA2)	6	DHW pre-heating as per "plus" function (without DHW request)
3	in heating mode upon request of the third Room Thermostat on the configurable AUX input	7	anti-freeze function on DHW internal components
		8	anti-legionella cycle in progress (not for this model - only available on models with DHW storage)

- ▶ To quit the **INFO** menu, press the button .

INFO for the technician

For information purposes only, we mention the Technical INFO menu which makes available a purely technical category of data, in addition to the data available in the user INFO menu, which can be displayed with a different procedure. This function allows you to view the history of the last 10 alarms occurred in the boiler (either RESET or SERVICE, see "Alarms - boiler block" on page 42) and other data. Being read-only, also in this case access to this menu does not affect the good working of the boiler.

- ▶ with the boiler in OFF mode, press the button **INFO** for 6 seconds;
- ▶ the display shows the symbol **INFO**, along with **RESET** or **SERVICE** ;
- ▶ to navigate through the available data, use the buttons **+ .III'** and **- .III'** . For the interpretation and use of data on a diagnostic level, please refer to the training courses and documentation for the Technicians.
- ▶ To quit the **technical INFO** menu, press the button .

Incidental malfunctioning





Avoid performing personally any intervention that are job of the technician, for example the ones on the electrical circuits, on hydraulic system or on the gas system, and whatever other operation that's not mentioned in this "User Guide" section and expressly allowed to the User. Always address yourselves to qualified personnel.

Boilers must be always equipped with original accessories only.

ITALTHERM S.p.A. is not responsible for damages caused by the incorrect, wrong or unreasonable use of not original materials.

The burner doesn't turn on

- ▶ if the room thermostat (or programmable room thermostat, or similar) is installed, check that it is really requiring the room heating;
- ▶ be sure the boiler is set on winter  +  or summer  mode (not in **OFF**). The reference symbols must be shown on the display (see "The front control panel" on page 7);
- ▶ in case the display shows **RESET** or **SERVICE**, or in case the boiler seems to be working in an inappropriate way, see "Alarms - boiler block" on page 42;
- ▶ check on the gauge that the boiler pressure is correct (1÷1.5 Bar **in a cold state**) or at least **not below 0.5 Bar**.

Shortage of domestic hot water production

- ▶ check the DHW temperature is not set on a too low value: if so, adjust it (see "Temperature adjustment" on page 10);
- ▶ call a qualified technician to check gas valve regulation;
- ▶ in the case of high withdrawals (especially if the water supply pressure is high and with models with low rated power) the temperature of the water produced could be lower than the set one;
- ▶ call a qualified technician to check, and eventually clean, the DHW exchanger.



Remark: where the water hardness value is too high, it is suggested the installation of a softening device, in order to prevent the limestone precipitation; this operation avoids a frequent cleaning of the coil.

Boiler inactivity

The effects of the periods of inactivity can be relevant in particular situations such as in flats used only for some months per year, most of all in cold places.

The user will have to decide to put the boiler in the **SAFETY SHUT OFF state** disconnecting all the supplies, or to **leave it on OFF mode (but electrically supplied) in order to let the Anti Frost Function work**. When there is the possibility of freezing it is convenient to chose between the advantages and the disadvantages of the SAFETY SHUT OFF and of the Stand By/Anti Freezing Way.

Safety shut off

- ▶ Turn off the general switch on the Electrical Supply Line of the Boiler;
- ▶ Close the Gas Tap;



When it is expected that the temperature is going to decrease under 0°C, call a technician to do the following:

- Fill the system with an anti-freezing solution (unless the system was already filled with said solution) otherwise it must be completely emptied. Notice that if it had been necessary to restore the pressure (because of possible loss) in an heating system already filled with an Anti freezing solution, the concentration of the solution could have decreased and it could not guarantee the Anti freezing Protection.
- Let the condense collector syphon be emptied unscrewing its inferior cap.
- completely empty the hot and cold sanitary water system, including the sanitary circuit and the boiler's sanitary exchanger.

Remark: the boiler is equipped with a system which protects the main components from the exceptional cases of mechanical lock, due to the inactivity in presence of water and scale. The anti-locking function can't work in Safety shut off mode, because of the lack of electrical supply.

(i) Before switching on the boiler again, have the circulating pump checked by a technician to make sure it is not blocked due to inactivity (for the technician: proceed as described in paragraph "Circulating pump rotor unlocking" on page 58).

Stand-by mode with anti-frost & anti-locking function

When the boiler is left in **OFF** mode during a period of inactivity, it will be protected against freezing by several functions provided in the electronic controller, which heat the parts involved when the temperature falls below factory set values.

The anti-frost heating is accomplished by turning on the burner and pump.

In addition, when the boiler is in stand-by, it periodically activates the main internal components to avoid rare cases of blockage due to inactivity in the presence of water and lime. This can also occur when the boiler is locked (red lamp on) provided that the system pressure is correct.

In order for these systems to be active:

- the boiler must be receiving gas and electricity;
- boiler must be left on **OFF** mode (**OFF** shown on the display);
- system pressure must be correct (1÷1.5 bar in a cold state, minimum 0.5 bar)

In case of gas supply failure, or if the boiler locks for other reasons (the display shows **RESET** or **SERVICE**) the burner won't turn on. Nevertheless, any time it is possible, the pump will work, making the water circulate in the system and reducing in this way the possibility of freezing.



(i) ATTENTION: the anti-frost protections cannot intervene in the absence of electricity. If you anticipate this possibility, we recommend you add a good brand of anti-freeze to the heating system, following the producer's instructions.

We recommend to ask directly the installer/technician about the type of antifreeze product put in the heating system during installation.

When the power comes back on, the boiler will check the temperature measured by the two probes and, if it suspects freezing verified by a particular automatic control cycle, alarm 39 will be triggered. For more details, see the relative description in the paragraph "Alarms - boiler block" on page 42.

(i) We recommend that you completely empty the hot and cold sanitary water system, including the sanitary circuit and the boiler's sanitary exchanger. The anti-frost function does not protect the sanitary circuit outside the boiler.

“Ambient Anti-Frost” Function

Note: if you want to use the “Ambient Anti-Frost” function that is often available in common room thermostats or chronothermostats, it is necessary to leave the boiler in Winter  +  mode and NOT in OFF mode.

 The “Ambient Anti-Frost” function does not protect the sanitary circuit outside the boiler and, especially, in areas where the heating system doesn’t reach. For this reason, we recommend that you empty the cold and hot sanitary water from the parts of the system that are at risk of freezing.

Installation

Law and regulation prescriptions for the installer



Always comply with national and/or local regulation about BOILER INSTALLATION.

Always comply with national and/or local regulation about WORK SAFETY of Personnel in charge of installation.

Characteristics of the room: as this boiler has an heat output lower than 35 kW (about 30000 Kcal/h), it is not required to install the appliance in a dedicated room, provided that the room complies with the regulation in force and that all installation rules assuring a safe and regular gas boiler operation, are strictly respected.



Permanent ventilation of the installation room is mandatory and extremely important when a boiler with air draught from the installation room (B... appliance type) is installed. Ventilation must be made and sized in compliance with Laws and Rules in force.

Presence of other appliances: the presence of other appliances (especially if they interfere with the boiler draught) can be forbidden by the regulation in force or can require modifications (e.g. the enlargement of the ventilation opening or the making of new ones).

Instructing the user: at the end of the installation, the installer must:

- explain the operation of the boiler and its safety devices to the user;
- give this user this booklet and the documentation within his/her competence, duly filled in where required.

Dimensions and connections

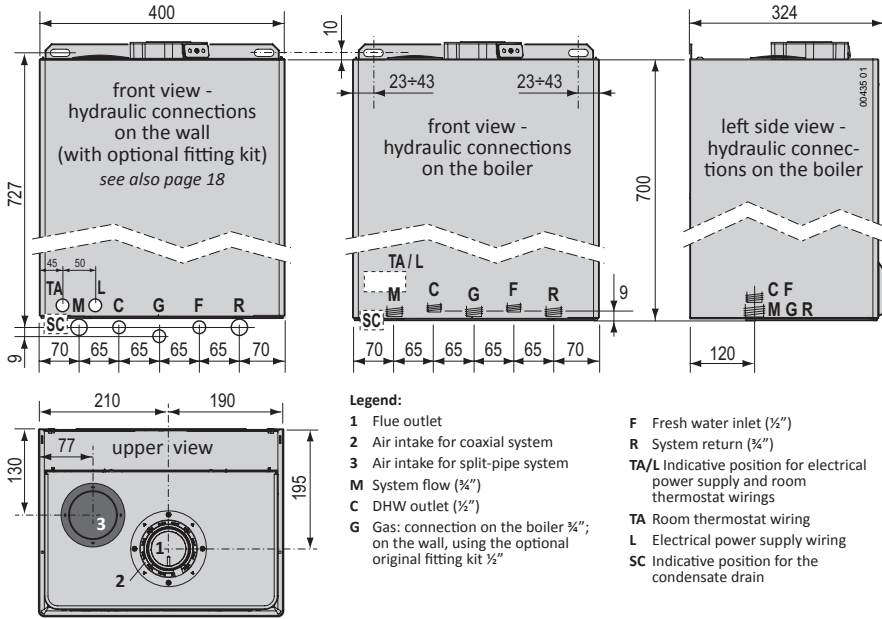

Pump capacity diagram

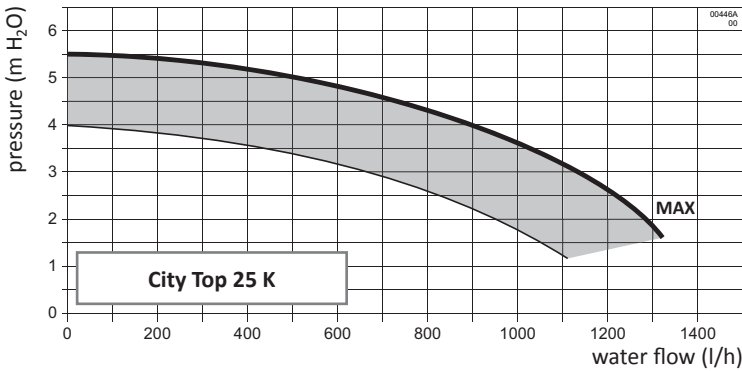

See also "Pump settings" on page 42. The curves **MAX** shown in these graphs refer to the head available to system at factory setting (see par. 35 on page 36) and are net of the load loss of the circuits inside the boiler. The area represents the working range with pump in modulating mode (see par. 33 on page 36)

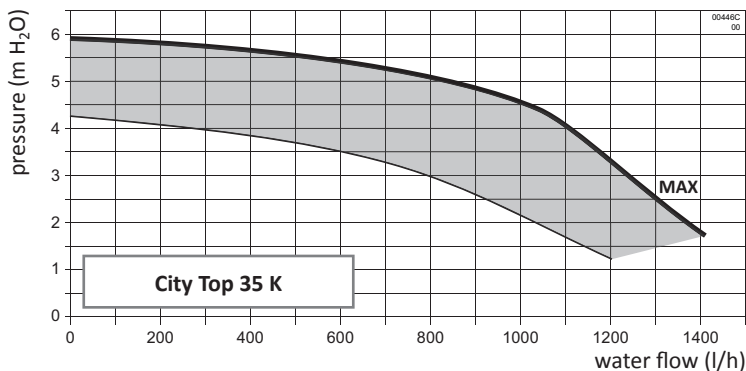

Warnings for the installation of optional kits or special systems

Floor heating system

(i) The safety thermostat(s) that protects the floor against overheating (that could damage the cladding, the structure or the system itself) must be installed on the flow starting end of the serpentine embedded in the floor itself. It should not be installed on the system flow pipe in proximity of the boiler, otherwise frequent and unjustified boiler locks, caused by its triggering, are possible.

Specifications for intake air

Air must be withdrawn from places free of pollutant (like fluorine, chlorine, sulfur, ammonia, alkaline or similar agents). In the event of installation of the boiler in atmospheres with not negligible presence of aggressive chemical substances (e.g. hairdressing salons, laundries) we recommend to foresee the air intake from outdoor, choosing the type C installation.

Domestic water supply characteristics

The cold water inlet pressure must be lower than 6 Bar. Besides, for an optimal boiler functioning, water pressure **should be more than 1 Bar.** A lower pressure could make difficult to restore correctly the pressure the heating system, and reduce the flow of hot water available from the boiler.

(i) In case of higher pressure it is **indispensable to install a PRESSURE REDUCER** upstream the boiler.

The cleaning frequency of the DHW heat exchanger depends on the water supply hardness. If the water hardness is more than 25° fr it's required to install a softener to bring the hardness below that value.

Besides, the presence of solid residuals or impurities in the water (for example in case of new systems) could compromise the correct functioning of the boiler. For DHW production systems, the regulation in force prescribes a safety filter to protect the systems.

(i) The condensing burner/exchanger assembly requires **particular characteristics for the heating system liquid**, more restrictive than the ones of the inlet domestic water. See the "Heating" section of the table "Technical data" on page 51.

Protection against freezing

Thanks to its antifreeze system, inner components could never reach a temperature lower than 5°C. This system is activated when the boiler is supplied by the electrical and gas lines, provided that the pressure in the heating system is correct.

(i) If some part(s) of the system external to the boiler could be subject to freezing risk, it is advisable to fill the heating circuit with, instead of water, an antifreeze liquid specific for heating systems, propylenic glycol based, following the instructions of its manufacturer. Pay attention to the correct product concentration: adding those substances to the heating water in incorrect dose could lead to the deformation of the seals and cause unusual noises during operation.

ITALTHERM S.p.A. will not be held responsible for consequent damages.

Instruct the User about the antifreeze function of the boiler and about the antifreeze product added in the heating system.

Outdoor installation in a partially protected place

This type of forced draught condensing boiler can be installed outdoor, but only in partially protected places.

The boiler minimum and maximum working temperatures are mentioned in the paragraph "Technical data" on page 51 and on the boiler data plate.

The materials used for the boiler installation, including the devices and/or the materials used for thermal insulation, should be so to **maintain their functionality** within the temperature range indicated on the data plate.

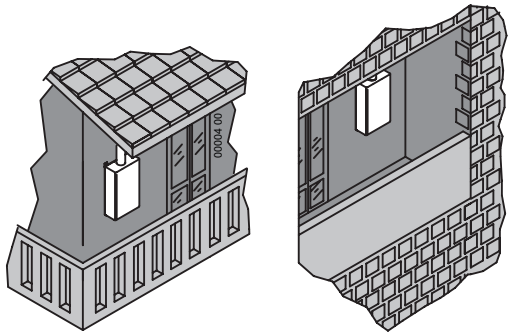

If the place where the boiler is located is converted **from outdoor to indoor** (e.g. veranda) it will be necessary to **verify the compliance** of the new configuration with the laws and rules in force, and to make the modifications required.

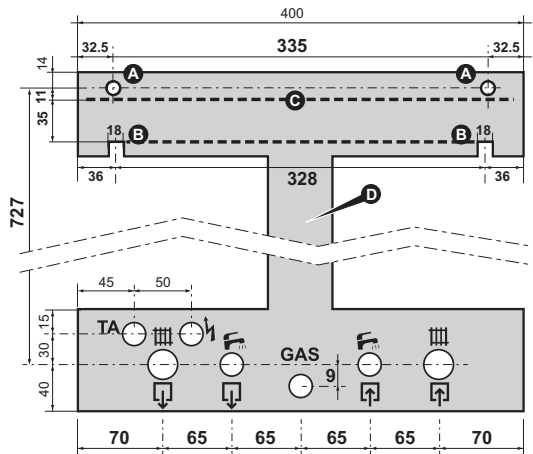
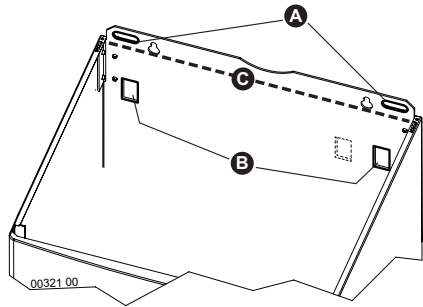

Positioning and fastening

Remark: A re-usable metal jig (D in the figure) can be ordered separately, so as to facilitate connections and fixing points positioning (when the original connection kit is used). If the metal jig and/or the original connection kit are not used, refer to the paragraph "Dimensions and connections" on page 15 for the position of the connections directly on the boiler.

- ▶ Locate the exact position of the boiler considering the sufficient clearances: at least 50 mm from each side, 50 mm from the front and 300 mm on the bottom side
- ▶ Choose the fastening/hooksing option among A or B, depending on the fixing devices used or already available if any (open hooks; wallplugs; "stud" type with nut).
- ▶ If the metal jig is used, hang it on the wall using the same fixing devices and the holes or slots A or B.
- ▶ Fix up the connections and all ducts for heating flow and return, cold water, hot water, gas and electrical cables, predisposing them in the holes of the metal jig or, as an alternative, respecting the measures in the paragraph "Dimensions and connections" on page 15. The upper edge of boiler's body, used as a reference in the paragraph "Sizing the flue system" on page 26, is represented by the dotted line C in the figure.

- **model 35 only:** pull upwards and remove the plastic blocks that hold the sides of the expansion vessel.

- ▶ Remove the jig (if used) and hang the boiler to the fixing devices, using the chosen holes or slots A or B.
- ▶ **Remove the plastic caps** placed to close the hydraulic connections and the condense outlet hose of the boiler.
- ▶ Proceed with the hydraulic, gas, electrical and flue connections following the instructions and warnings reported in the following paragraphs.

	Heating Flow (3/4")
	Hot Water Outlet (1/2")
GAS	Gas (1/2")
	Cold Water Inlet (1/2")
	Heating Return (3/4")
	Electrical Power Supply
TA	Room Thermostat

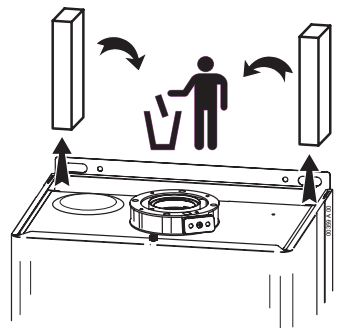

(i) The connections of the boiler are engineered to fit plain couplings with screw ring, interposing a plain gasket of suitable size and material, that ensure a reliable seal even without excessive tightening force. They are NOT suitable for hemp, teflon tape or similar materials

Hydraulic system (DHW and heating)



Make sure that the hydraulic and heating systems ducts **are not used as earth connections of the electrical system**. They are absolutely NOT SUITABLE for such a use. Besides: they don't guarantee the earth dispersion; in case of electrical fault they could generate a fulguration risk; there could take place galvanic currents in the pipings and consequent corrosion and hydraulic leaks.

Advices and suggestions to avoid vibrations and noises in the system

- ▶ Do not use pipes with reduced diameters;
- ▶ Do not use bends with small radius and reductions of important sections.

Cleaning and preservation of the systems

The efficiency, the reliability and the safety of the boilers, as all generic thermal systems and components, depend strictly on the features of the water that supply them and on their treatment.

A proper treatment of the water improves the protection of the systems against corrosions (and therefore perforations, noise, leaks, etc.) and limestone incrustations that drastically reduce the efficiency of the thermal exchange (consider that 1 mm of limestone incrustations reduces of 18% the thermal exchange of the heating element on which it has been formed).

ITALTHERM guarantees its products only if the characteristics of the water comply with UNI 8065, reported also in laws on energy saving.

(i) Thoroughly wash the heating system with water, before connecting the boiler. This will eliminate residual like welding drops, slag, hemp, mastic, mud, rust and other dirt from pipes and radiators. Otherwise, these substances could enter the boiler and damage the internal components (pump etc.).

- ▶ **In case of old or very dirty systems, to wash them use specific, proven efficiency products**, in the suitable quantity and following the instructions of its manufacturer.
- ▶ If the water on boiler inlet is harder than 25° fr, it's required to install a softener to bring the hardness below that value, as required by the reference regulation.
- ▶ For floor system and generally all low temperature systems, the water treatment product must have filming action (protection against corrosion and incrustation) and action against bacteria and algae.

Heating system

- ▶ Connect the safety evacuation ducts of the boiler to an evacuation funnel. If safety valves are not connected to an evacuation device, their intervention could flood the room. The manufacturer cannot be held responsible for any damage arising from that situation.

Condense drain

Insert the flexible pipe of condense outlet inside the outlet funnel (or other inspectable connection device) properly installed for this purpose, or in the outlet funnel of the safety valve, in case of the above mentioned outlet is able to receive the acid liquids of the condense as foreseen by the norms in force in matter of condensing boilers.

(i) Requirements for the condense drain system:

- It must be made in a way that doesn't allow the condense freezing or other blockages, and it must not allow modifications or obstructions
- before the first starting up of the appliance, ensure that the condense can be correctly drained
- if the intended use of the building unit foresaw the installation of a condensate neutralization system, make sure that you have the relevant instructions for use, cleaning and maintenance

Heating system filling and pressuring

Once all system connections have been carried out, proceed with system filling. This operation should be made manually, with care, respecting the following steps:

(i) Check that the boiler is **not** electrically supplied (to avoid the activation of the automatic filling system).

- ▶ Open the radiators venting devices;
- ▶ Check that the plug of the automatic air vent, incorporated in the boiler circulator, is unscrewed: if not, unscrew it and leave it unscrewed, even afterwards, for normal operation;
- ▶ If it's required to fill the system with anti-freeze solution, do this operation, then hermetically close the connection or the valve used to put the solution in, to allow the pressurization.
- ▶ Gradually open the filling cock **2** by using a screwdriver;
- ▶ Check the correct functioning of automatic venting devices, eventually installed;
- ▶ Close the radiators venting devices as soon as water flows out of them;
- ▶ Make sure, by reading the pressure gauge **1**, that the pressure reaches the optimal value of **1.0 bar (max 1.5 bar)**;
- ▶ Close the water filling cock **2** and bleed each radiator again;
- ▶ Repeat the venting and pressurization operations until the air is completely purged from the system.

Remark: when the boiler is power supplied, regardless its working mode, the system pressure will be checked and automatically restored, if necessary.

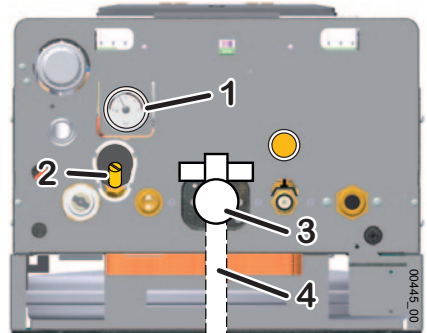

Gas connection

Due to various installation possibilities, the gas cock **3** supplied with the original Connections Kit has a simple male $\varnothing \frac{1}{2}$ " connection, facing the rear of the boiler. *The gas pipe 4, upstream the gas cock 3, should be supplied by the installer.*



While connecting the gas inlet of the boiler to the gas supply piping, it is MANDATORY to insert a PLAIN GASKET, whose dimensions and material must be adequate. Connection is NOT suitable for hemp, teflon strip or similar materials. Because of the type of fitting, the use of those materials does not make the suitable seal with consequent gas leaks!



This boiler is designed and prepared to be supplied with Natural Gas G20 (Methane).

It can be set, just by means of electronic settings, but always by a qualified technician, to operate with Commercial Propane G31 or Air/Propane G230.

It must never be used with Butane gas G30 (that can be present, pure or mixed with Propane G31, in the portable gas bottles for cookers) therefore, if the boiler is prepared for operation with commercial Propane G31, we recommend to inform the supplier of the fuel, for example, by applying a suitable warning on the gas tank or in its immediate vicinity, so that it is visible to the employee when it is being refilled.



Using Propane gas G31, it is absolutely necessary to install a pressure reducer upstream the boiler. Failure to do this, the gas valve of the boiler will get damaged. The inlet gas pressure must be compliant with the one specified in "Technical data" on page 51.



The gas connection, as generally the boiler installation, must be done by qualified personnel as prescribed by the regulation in force, because a faulty gas connection could lead to fire, explosion and other very serious damages to persons, animals and objects. The manufacturer cannot be held responsible for any damage arising from that situation.

► Verify what follows:

- cleaning of all system gas pipes in order to avoid the presence of work residuals that could compromise the correct boiler functioning;
 - gas line and ramp conformity with laws and rules currently in force;
 - internal and external tightness of the gas system and connections;
 - supply pipe must have a section greater than or equal to the boiler one;
 - supply gas must correspond to the one for which the boiler has been set: otherwise, it's mandatory to ask to qualified personnel to set the boiler for the correct gas type;
 - an interception valve must be installed upstream the appliance.
- Open the meter valve and purge the air that is inside the system pipes (including all the appliances).

Electrical connections



The link of the room thermostat works with a safety extra low voltage (SELV); connect it to the voltage free contacts of the room thermostat/chronothermostat. **On NO account must any electrical voltage be applied** to these terminals.



All low-voltage wirings (e.g. Room Thermostat or Chronothermostat for trade) must be kept separate from power supply cables, as to avoid boiler malfunctioning due to electrical noise. It is advisable to use separate tubes for them.



During the connection of cables from the boiler, make sure that they are not tight and make a slack that allows the control panel to be fully tilted.

The boiler must be connected to a 220÷240V - 50Hz electrical power supply. In any case, the power supply voltage must be within the range -15% ... +10% from the nominal value (230V); otherwise it may cause malfunctions or failures. It is necessary to respect the polarities L-N (Live L=brown; - Neutral N=blue) and the earth connection (yellow-green cable).



Place upstream the boiler a bipolar switch in compliance with the regulation currently in force. The installation must be made complying the regulation currently in force and generally with the standard craft rules.

For the general electrical supply of the appliance the bipolar switch should be used. The use of adaptors, multiple taps and extensions is not allowed.

If the supply cable must be replaced, use one of the following cable types: H05VVf or H05-VVH2-F. **It is mandatory the earth connection in accordance with the rules actually in force.** To replace the cable, open the control panel cover, unlock its fastening device and disconnect it from the terminals. Install the new cable proceeding in the reverse way. When connecting the cable to the boiler, it's mandatory:

- to leave the Earth wire about 2 cm longer than the other (Live and Neutral) wires;
- to lock the cable upstream the terminals by means of the suitable fastening device.



Electrical safety of the appliance is only achieved when it is well connected to an efficient earthing system, executed as indicated by the safety rules actually in force.

A qualified technician must check that the electrical system is in line with the maximum power allowed by the boiler, indicated on the data plate, with particular attention to the cables section.



ITALTHERM S.p.A. declines any responsibility for damages to persons, animals or things caused by the faulty or missing connection of the boiler earthing and by failure to comply with the rules.

Flue systems

General indications

To grant the functionality and efficiency of the appliance it is indispensable to realize intake and outlet ducts using flue accessories specific for condensing boilers.

(i) WARNING: the specific flue accessories components for condensing boilers, especially the parts which are in touch with the flues outlet, are so projected because they are made with **plastic materials acids resistant**, but because of their nature, **they are not suitable to resist to the higher temperature** of the flues of the traditional boilers. So **it is not possible to use traditional flue components for the outlet ducts of the condensing boilers, neither vice versa.**

(i) When installing the pipes, we recommend lubricating the inside of their gaskets exclusively with **silicone** lubricants since their material (EPDM peroxide) is not compatible with other types of oils or greases

If it is possible, we recommend to foresee (referring to the direction of the air/flue, see examples on page 25) an upwards slope for all the intake and outlet ducts, in order to:

- ▶ PREVENT the water or dust or other objects entrance inside the INTAKE duct. In case of coaxial ducts, use the special horizontal terminal, which is especially built to respect these slopes only for the first length of the intake duct;
- ▶ FACILITATE, in the OUTLET duct, the flowing back of the condense towards the combustion chamber, which is built to work in these conditions and to discharge the condense. If so it is not possible, or if there are some points where the condense stagnates inside the outlet duct and if it is not possible to avoid this through a modification of the slope of the ducts, these points must be drained using the specific kit of condense collector (consult the commercial catalogues of the original accessories), and ducting the condense formed towards the outlet duct as foreseen by the norms in force in matter of condensing boilers.

Air intake and flue outlet terminals should be protected by suitable approved flue accessories, to avoid environmental elements penetration.

Carefully follow the indications foreseen by the specific laws in force.

Respect the minimum and maximum flue length prescribed (see "Sizing the flue system" on page 26).

In case of flue outlet on wall, the positions and the distances prescribed by the regulation must be respected.

The **outlet duct is the assembly of components that connect the boiler to the point where the flues are discharged**. The outlet can be directly outdoor only in the case foreseen by the law in force and using at the end of the outlet duct a specific terminal.

In case you foreseen to discharge the combustion products through a **chimney** (for single user) or a **common flue** (for multiple users) the part of the evacuation system (the chimney or the flue) to which the outlet duct of the condensing boilers is connected, **must be declared suitable for this purpose by its producer**. In case of common chimney, keep in mind the laws in force regarding the typologies and rates of users.

Don't lean the flue pipe into the chimney, but stop it before the inner surface of the chimney. The axis of the flue pipe must intersect the axis of the chimney or of the flue duct.

In general situations the **evacuation systems** of the combustion products **must be properly declared suitable from the producer of the same system** for wet functioning, or **must be supplied by the appliance's producer** (gas boiler).

If the chimney (or the flue) were not suitable, it would be indispensable, to use it, to canalise it through specific ducts, so for example through the original flue accessories.

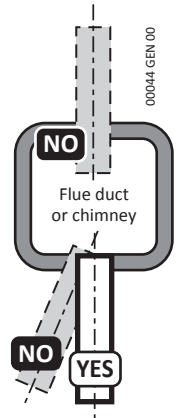

Sizing C₆₃ systems

Remark: if a flue system ITALTHERM original is installed, do NOT use this paragraph, but please refer to "Sizing the flue system" on page 26.

If you choose to use aftermarket flue components (this is suitably allowed by the C6 certification), **however strictly certified for condensation**, the installer will have to size the inlet and outlet system so as to obtain, during operation, **Delta P outlet/inlet** values within the specific min/max range of the boiler. The necessary information can be found in "Technical data" on page 51, "Connections" section, while the specific ones of the components must necessarily be supplied by their manufacturer

Examples of installation of intake and outlet ducts

We give you some correct and wrong examples of installation of intake and outlet ducts for condensing boilers (the slope are voluntarily represented in an exaggerated way).

A = Intake; **S** = Outlet. **1:** the most functional and economic solution is to let the condense come back towards the boiler**. **2-3:** if an obstacle prevents to install the ducts upwards, it is necessary to install condensate collectors, so as to avoid stagnations. **4:** if, respect to the air flow, the slope of the intake ducts is upwards (for their all length or at least only for the external tract) this is sufficient to prevent the rain water to reach the burner's fan*. **5:** so the intake must not be downwards*. **6:** do not let the condense go out from the flue outlet terminal. **7:** the coaxial intake/outlet duct must be installed so as the flues are upwards, and so the condense discharge itself towards the boiler. The terminal tract with intake head and outside with an outlet out axis must be horizontal placed and it is equipped with ribs which prevents the water entrance* in the external intake duct. The internal outlet duct is upwards and canalises the condense in the correct direction.

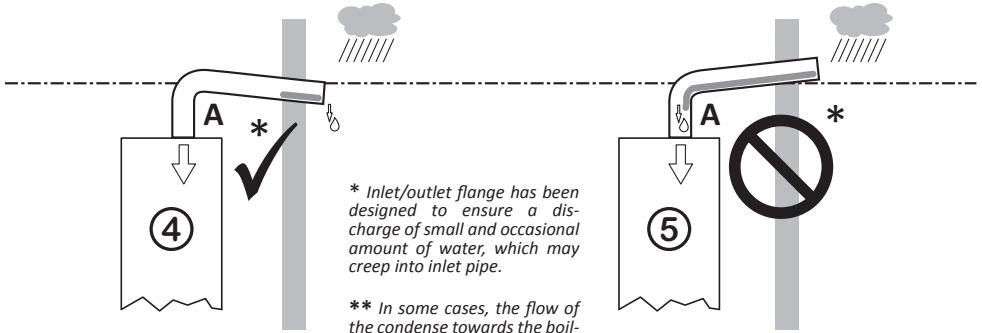
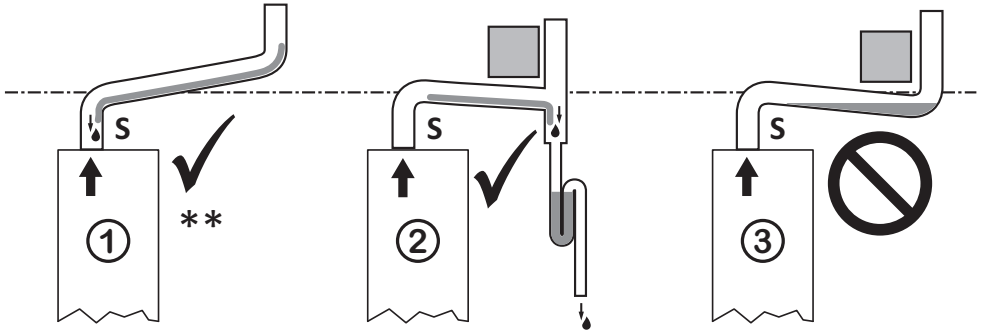

* Inlet/outlet flange has been designed to ensure a discharge of small and occasional amount of water, which may creep into inlet pipe.

** In some cases, the flow of the condense towards the boiler is not allowed: see "Allowed flue types" on page 28.

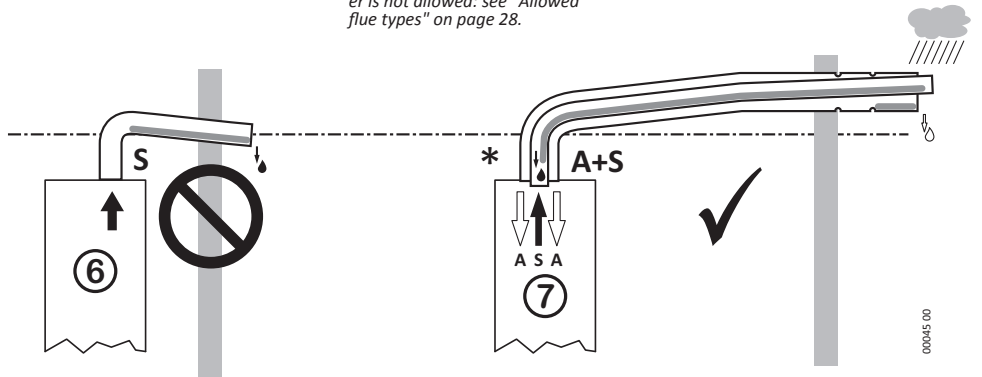

00045.00

Sizing the flue system

(i) See "System length tables" on page 27 to size the ducts according to: boiler model; gas type; distance to be covered; pipes diameter.

In special cases (duct section 50mm diameters and/or considerable lengths) it is possible to change few parameters to the boiler settings (by a technician). **Incorrect sizing would lead to problems** such as: incorrect combustion; out-specific emissions and returns; alarms for boiler block; fouling or premature wear of the combustion system.

Separate pipe system (C₄₃, C₅₃, C₈₃, C₉₃ *)

* **Remark:** Split pipes allow to make also C₁₃ and C₃₃ flue systems.

** The dimensions on the duct axis are referred to the upper edge of the boiler's body, close to the mouth of the first 90° bend. The difference of level due to the slopes are not considered.

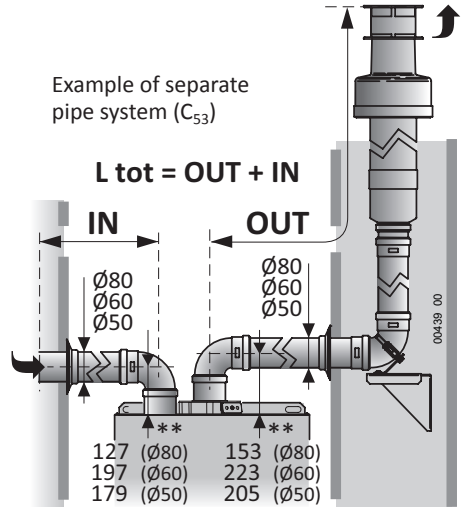

Coaxial system (C₁₃, C₃₃)

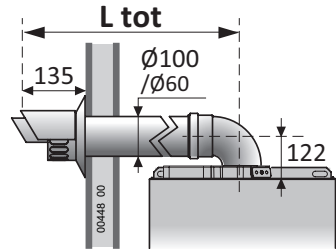
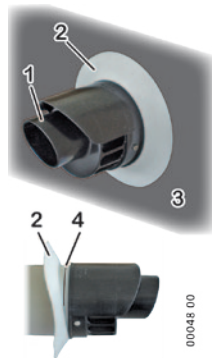
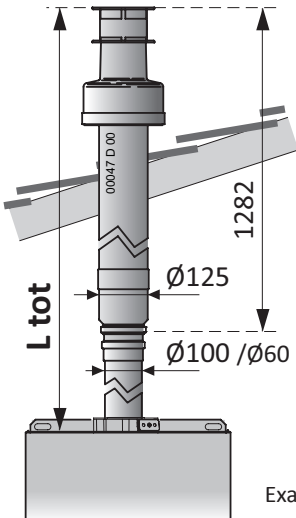

(i) Put the outlet coaxial horizontal terminal with the outlet head **1** UPWARDS, as indicated in the picture, respecting the measures in the drawing. Check that the elastic sealing collar **2** is housed in the groove **4** and against the outside wall face **3**.

Example of vertical coaxial system (C₃₃)

Flue system length

How to use the tables

- ▶ Each table is related to one model only and it's valid for the indicated gas types
- ▶ The data differ according to the diameter of the inlet and outlet system and the type of ducts used: rigid (smooth) or with flexible pipe (corrugated). Systems consisting of mixed duct types are not considered

- ▶ **L tot** is the maximum system length (physical of linear piping + equivalent of bends):
 - in the case of separate systems, it is the sum of the total lengths of the inlet sections (IN) + outlet (OUT). The horizontal system includes the 2 bends necessary to make the ducts horizontal, ie the 90° one on the air inlet connection and the 90° one on the flue outlet connection of the boiler
 - in case of coaxial systems, it's the physical length of this system. The horizontal system includes the first 90° coaxial bend on the flue connection of the boiler, to make the duct horizontal
- ▶ Bend, 90° or 45°
 - They are always intended as **additional** bends, that is to say that in the horizontal systems are those eventually installed **in addition** to those already foreseen for those systems. They must be included in the calculation of the **L tot** based on their equivalent length shown in the table.

System length tables

City Top 25 K	gas: G20 - G31 - G230		with factory settings		
	Diameter	type	L tot min÷max (m)	90° bend (m)	45° bend (m)
∅ 80mm	rigid vert.		1 ÷ 62	1.5	0.9
	flexible		1 ÷ 62		
∅ 60mm	rigid horiz.		1 ÷ 18	1.8	1.4
	rigid vert.		1 ÷ 20	1.8	1.4
	flexible		1 ÷ 20		
∅ 50mm	rigid horiz.		1 ÷ 8	2.0	1.4
	rigid vert.		1 ÷ 10	2.0	1.4
	flexible		1 ÷ 10		
∅ 100/60	coaxial horiz.		1 ÷ 10	2.0	1.0
	coaxial vert.		1 ÷ 12	2.0	1.0

City Top 35 K	gas: G20 - G31 - G230		with factory settings		
	Diameter	type	L tot min÷max (m)	90° bend (m)	45° bend (m)
∅ 80mm	rigid vert.		1 ÷ 62	1.5	0.9
	flexible		1 ÷ 62		
∅ 60mm	rigid horiz.		1 ÷ 18	1.8	1.4
	rigid vert.		1 ÷ 20	1.8	1.4
	flexible		1 ÷ 20		
∅ 50mm	rigid horiz.		1 ÷ 8	2.0	1.4
	rigid vert.		1 ÷ 10	2.0	1.4
	flexible		1 ÷ 10		
∅ 100/60	coaxial horiz.		1 ÷ 10	2.0	1.0
	coaxial vert.		1 ÷ 12	2.0	1.0

Allowed flue types

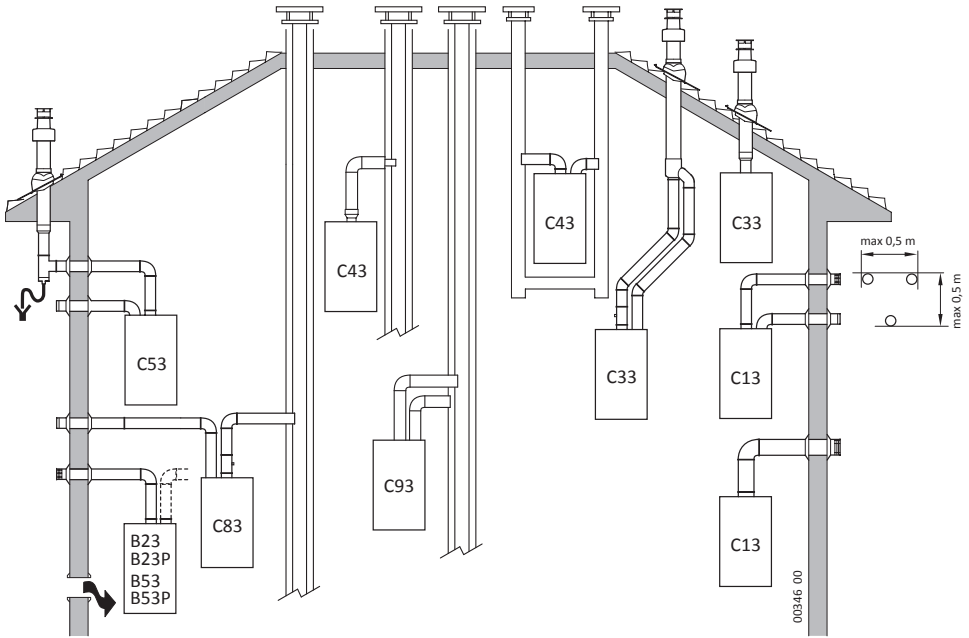

The flue duct and its connection to the chimney should be made in compliance to National and Local Regulation in force. – It's mandatory to use ducts that resist to temperature, condense, mechanical stress, and that are tight. – Not insulated flue ducts potentially lead to dangerous situations.

Air inlet from the room and flue outlet outside.

B23
B23P

REMARK: air inlet opening ($6 \text{ cm}^2 \times \text{kW}$).

...P: flue system designed to work at positive pressure.

B53
B53P

Same as B23 - B23P but flue system supplied with the appliance.

C13

Coaxial system, to wall. Ducts can start separate from the boiler, but outlets must be coaxial or close each other (within 50 cm) as to be subject to similar wind conditions.

C33

Coaxial system, to roof. Ducts can start separate from the boiler, but outlets must be coaxial or close each other (within 50 cm) as to be subject to similar wind conditions.

C43

Separated outlet and inlet, in shared chimneys subjected to similar wind conditions (natural draught chimney). **The condense flow towards the appliance is not allowed.**

C53

Separated outlet and inlet, to wall or roof or anyway to zones with different pressure.

REMARK: outlet and inlet must never be placed on opposite walls.

C63

Some outlet and inlet types (see "Technical data" on page 51) that can be made by using ducts traded and certified separately.

C83

Outlet in single or shared chimney and inlet from wall. **The condense flow towards the appliance is not allowed.**

C83

Separated outlet and inlet, in shared chimney.

C93

Cavediums dimensions must ensure a minimum interspace between the outer wall of the chimney and the inner wall of cavedium:

- 30 mm for circular section cavediums
- 20 mm for squared section cavediums



WARNING: Hereby described operation can be performed by qualified technicians only.



When regulation/measuring is over, remember to verify the absent of gas leakages. Do not use free flames to detect gas leakages



The gas valve, exception the PIN plug and the upwards connections, works in **NEGATIVE PRESSURE**. We do not recommend to use products for the detection of the gas leakages where not expressly indicated, because these products could penetrate inside the gas valve disturbing its normal functioning.



The siphon is an integral part of the combustion system and it's necessary to check its seal during every technical intervention on the boiler. Verify that both caps (upper and lower) are properly and completely screwed.



Verify that the combustion products do not go out from the outlet of the condense.



The condense syphon trap of the boiler is equipped with a special device which closes when dry. Anyway, the seal is guaranteed only when the syphon trap is filled with liquid. So, at the end of the first firing / commissioning operation, it is recommended to check that the syphon trap contains liquid, e.g. checking that liquid exits the condense drain of the boiler.



Before switching on the boiler, **make sure the circulating pump is not blocked** due to inactivity (proceed as described in paragraph "Circulating pump rotor unlocking" on page 58).



During the commissioning of the **new boiler**, it is necessary to **run the burner for 30 minutes before checking the combustion** because, in that period of time, any residual fabrication vapours could cause false results in the combustion products analysis.

Remark: during the first 10 minutes of electrical power supply, the re-ignition delay in heating mode might be nil.

- The ignition electronics does several ignition attempts, to avoid blocking the boiler when the ignition fails sporadically.
- When the gas supply pipe is filled with air (e.g. in case of new installation) it may be necessary to repeat the ignition cycle several times.
- The boiler is factory regulated and tested. Anyway it's advisable, during the commissioning, to check that the regulation is correct.

First starting up

The first ignition operations consist in verifying the correct installation and functioning, and in the eventual regulations which are necessary:

- ▶ verify that the data of the plate correspond to those of the net supply (electrical, water, gas);
- ▶ verify the absence of the gas leakages from the connections upwards the boiler;
- ▶ verify the proper realization and the efficiency of all the boiler connections (water, gas, heating system and electrical system);

- ▶ verify the presence of the permanent air/ventilation outlets, correctly dimensioned and working, as foreseen by the National and Local laws depending on the appliances installed;
- ▶ verify that the evacuation flue duct corresponds to the National and Local laws and that is in good and efficient conditions;
- ▶ verify the correct functioning of the system of the outlet condense, also in the external parts of the boilers, i.e. the eventual condense collector installed on the flue outlet: verify that the liquid flow is not obstructed and that there are not inlets of gaseous combustion products inside the system itself;
- ▶ verify that the passage of the air burning and the evacuations of the flues and of the condense will be made correctly accordingly to National and Local laws in force;
- ▶ verify that the conditions for the air ventilation are granted, in case of a boiler placed inside a piece of furniture;
- ▶ vent the primary exchanger, proceeding as described in the paragraph "Venting the primary exchanger" on page 32;
- ▶ verify and, if necessary, change the boiler electronic settings to adapt its work to particular system requirements (see "Main boiler parameters (PC)" on page 34);

(i) Before switching on the boiler, **make sure the circulating pump is not blocked** due to inactivity (proceed as described in paragraph "Circulating pump rotor unlocking" on page 58).

- ▶ verify that the combustion is correctly regulated: go on in this chapter as described in the paragraph "Combustion test" on page 37;

(i) During the first ignition of the brand new boiler, it is necessary that burner works for at least 30 minutes, before performing combustion checks. During this time, the fumes of the eventual residual manufacturing materials are produced, and they could alter the measured values.

- ▶ verify the correct functioning of the boiler in heating and domestic hot water version;
- ▶ fill in the foreseen documentation and leave to the user the copy of his competence.

Maintenance operations

The periodically maintenance operations consist in cleaning the main parts of the boiler, in the further functioning proof (especially those described by the laws in force), and in the eventual regulations, which could be necessary:

- ▶ verify the absence of the gas leakages from the connections upwards the boiler;
- ▶ verify the conformity, efficiency and good conditions of the connections to the boiler (water, gas, heating and electrical system);
- ▶ verify the presence of the permanent air/ventilation outlets, correctly dimensioned and working, as foreseen by the National and Local laws depending on the appliances installed;
- ▶ clean the burner, the exchanger and the funnel of the condense: go on as described in the paragraph "Combustion group cleaning and check" on page 32;
- ▶ check that the internal parts of the boiler are in good condition and clean;

- ▶ verify that the passage of the air burning and the evacuations of the flues and of the condense will be made correctly according to National and Local laws in force;
- ▶ verify the correct functioning of the system of the outlet condense, also in the external parts of the boilers, i.e. the eventual condense collector installed on the flue outlet: verify that the liquid flow is not obstructed and that there are not inlets of gaseous combustion products inside the system itself;
- ▶ verify that the conditions for the air intake are granted, in case of a boiler placed inside a piece of furniture;
- ▶ when prescribed, or if it is necessary (i.e. if you find excessive residual in the combustion group or in the funnel of the condense), verify that the combustion is correctly regulated: go on in this chapter as described in the paragraph "Combustion test" on page 37;
- ▶ verify the correct functioning of the boiler in heating and domestic hot water version;
- ▶ if necessary, vent the primary exchanger, proceeding as described in the paragraph "Venting the primary exchanger" on page 32;
- ▶ fill in the foreseen documentation and leave to the user the copy of his competence.

Access to the inside of the boiler

1. Unscrew the casing fixing screws **1** and **2**;
2. pull the casing **3** outwards, then push it upwards (to unhook it from the tongues **6**) and remove it;
3. unscrew the screws **5** and **6**, then slide the control panel **7** upwards and overturn it downwards;
4. after the regulations, close the boiler repeating everything in the other sense, carefully hooking the casing **3** to the tongues **4**.

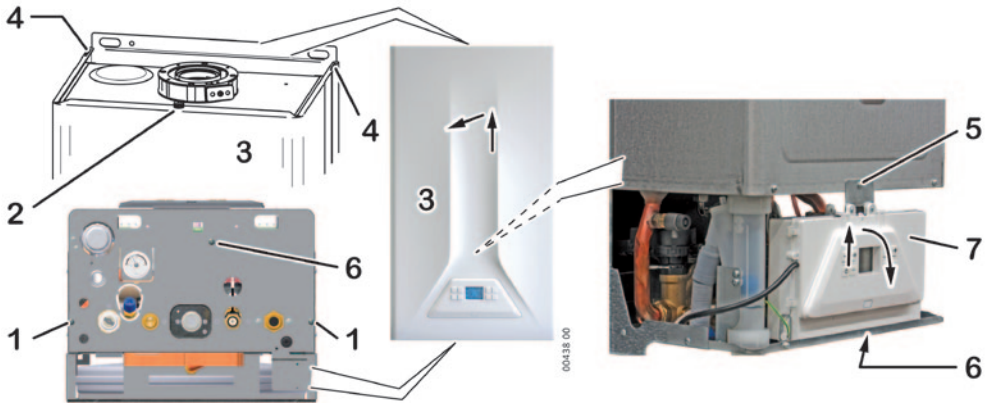

Venting the primary exchanger

When commissioning the boiler, we recommend to check that there is no air in the primary circuit of the combustion unit. Do this operation also during the combustion unit cleaning, if you hear the typical air bubble noise.

- ▶ Locate the **combustion unit manual venting valve** (item **8** in the following picture) and, to avoid wetting the boiler inside, insert a length of flexible hose, with suitable diameter, on its fitting, then direct the other end towards a drain (or a container to collect the anti-freeze solution);
- ▶ start the "circuit venting" mode by activating the **Parameter 07** (see "Main boiler parameters (PC)" on page 34);
- ▶ slowly open the venting valve **8** and restore the system pressure when necessary;
- ▶ when no more air comes out from the venting valve **8**, close the valve and reset the **parameter 07** to **0**;
- ▶ restore the system pressure and, if needed, the concentration of additive liquid.

Combustion group cleaning and check



Switch off the boiler and disconnect it from the electrical supply.



Be sure that the parts are not hot and eventually wait the time necessary to cool them;



Because some contacts with the fine dust and acid condense may occur, we recommend to wear the proper devices for the personal protection (i.e. glasses, gloves, masque)



Warning: do not wash or damage the insulating coverings inside the combustion chamber.



The replacement of gasket on the ends of the pipe **04** is mandatory. Please get the original spares.

- ▶ Open the sealed chamber;
- ▶ disconnect the two connectors **2** from the fan;
- ▶ disconnect the connector **10** from the ignition/detection electrode **11**. **Attention: do not dismantle the electrode from the combustion group**;
- ▶ remove the fastening clip **3**; unscrew the nut **5** which fixes the gas pipe **4** to the gas valve; pull out the gas pipe **4** from the fan/air-gas-mixer assembly;
- ▶ unscrew, following the stamped sequence, the four nuts **1** which fix the burner group **12** (composed of fan, hose and burner) to the primary exchanger. Remove the burner group;



Do not disassemble the burner group and do not dismantle the ceramic fibre plate from the bottom of the exchanger.

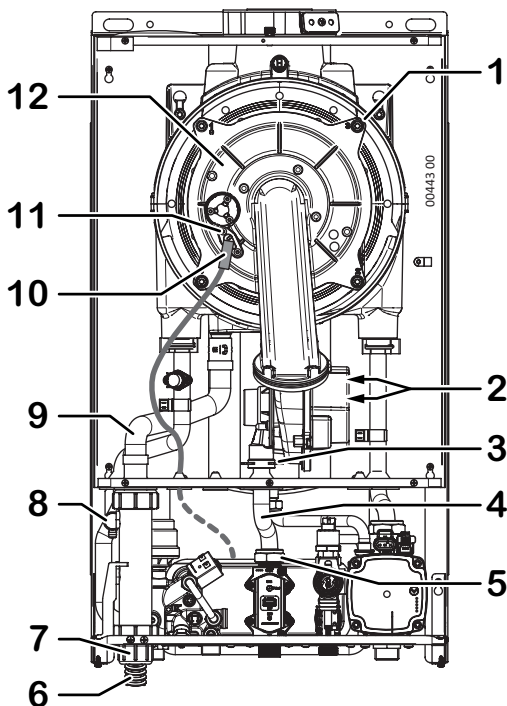

- ▶ check the integrity of the insulating coverings inside the combustion chamber;
- ▶ on the burner cover, check the integrity of the fireproof fibre gasket and of the silicone rubber one;
- ▶ check that the burner do not present deposits, foulings or excessive oxidations and that all the holes are free;
- ▶ clean the cylinder of the burner **ONLY IF IT IS NECESSARY** and only **DRY**, through a **NOT METALLIC** brush, with movements on the burner's axis, from cover outwards;
- ▶ clean softly the burner electrode, and check that the minimum space is 3.4mm to 5.4mm;

(i) Do not damage the insulating coverings inside the combustion chamber and don't deform the holes of the burner. If the burner works correctly, it will be of black colour but clean or in any case with few deposits, not scaled and easy to remove.

- ▶ slip off the outlet condense pipe **9** from the connection on the siphon. It's advisable to put the end of the pipe in a container or to extend it with a suitable pipe, to divert the dust that detaches from the primary exchanger during the cleaning, outside the boiler;
- ▶ **to clean the primary exchanger:**
 - prior to brushing the exchanger's coils, carefully remove, by a powerful vacuum cleaner, the solid residuals of combustion; don't use air jets now;
 - then clean the primary exchanger coils by a **NOT METALLIC** brush and remove the residuals again by using the vacuum cleaner;
 - if necessary, clean the coils using compressed air;
 - vacuum clean the residues from the condense pipe **9**.

- ▶ locate the lower cap **7** of the siphon and put a collector for liquids under it. Unscrew the cap. Let the siphon empty itself. Pour water into the combustion unit to rinse away any residuals. Inside the cap **7**, a layer of residual could be present (max 1÷2mm): remove it;

Remark: *an excessive quantity of residual is an indicator of malfunctioning or in any case it is not a normal situation. Locate the reasons and solve the problem, so remove the siphon unscrewing the superior and lateral connectors, and the screw of its support bracket. Accurately clean the siphon and be sure that its condense inlet pipe **9** and condense outlet pipe **6** are clean and not obstructed.*

- ▶ Reassemble all the components in the backwards order and opposite sense and check the combustion.

PCB parameters settings (technician menu)

These settings are reserved to Technician only. The procedure how the get in the boiler parameters is known by technician only thanks to a combination of steps which allows to gain the boiler parameters.

A few of these settings allow to optimise and tailor the boiler working, while a few others allow to set the boiler during maintenance operation.

The 2-digits display on the left side of the display indicates the number of the parameter. Instead, the 3-digits display on the right side is referred to the parameter value (setting) the parameter is set on.

(i) In case of PCB replacing, check all of the parameter settings otherwise set them properly. Please, do not modify any firm setting if this is not required.

Main boiler parameters (PC)

The parameters listed in the following table are limited to those described in this handbook. The complete parameter list is available in the documentation for the technician.

Parameter	Adj. range (fact. set.) and values	Description
01	0...2 (0)	Type of GAS supply
	0	for Natural Gas (G20) supply
	1	for Commercial Propane (G31) supply
	2	for Air/Propane (G230) supply
	To change the type of gas supply, it is necessary to follow the complete instructions described in the paragraph "Gas conversion" on page 41.	
02	0; 1 (0)	Heating flow temperature setting range
	0	Normal setting, suitable for plants with radiators. This allows the user to adjust the system flow temperature, by acting on buttons + .III° and - .III° , within the high-temperature range
	1	Reduced setting, suitable for low temperature plants. This allows the user to adjust the system flow temperature, by acting on buttons + .III° and - .III° , within the low-temperature range.
	<i>Remark: in case of mixed plants (with high and low temperature) thanks to optional kit, set low range (value 1) (please also refer to documentation provided with the kit).</i>	
03	—	It indicates the CH boiler power during the soft ignition phase. We recommend to leave the factory setting unchanged.
04	0...99 (*)	It indicates the CH boiler power according to the maximum nominal boiler power.
		<i>Remark (*): The factory setting depends on the model: see "CH Power Input adjustment tables" on page 38.</i>
	See details in "Max heating power adjustment" on page 39.	
05	0...2 (0)	Pump functioning mode during heating working
	0	intermittent for normal applications <i>(with eventual delay defined by parameter 06)</i>
	1	always on (to fit the needs of particular plants)
	2	always off (use only when external pumps are foreseen).
	<i>Remark: The pump will be anyway activated in all other circumstances, e.g. during the DHW functioning or for anti-freezing or anti-lockout functions.</i>	
06	0...15 (3)	Value in minutes. Delay of boiler re-ignition after set Central Heating temperature has been reached.
		<i>(This parameter works only if par. 05 = 0)</i>

Parameter	Adj. range (fact. set.) and values	Description
07	0...3 (0)	Auxiliary maintenance functions
	0	Disabled - normal operation of the boiler <i>(Remember to set this value to 0 at the end of work)</i>
	1	function Bleeding on heating side - boiler puts 3-way valve on the heating side and pump is continuously powered
	2	function Bleeding on DHW side - boiler puts 3-way valve on the DHW side and pump is continuously powered
	3	function Bleeding both Heating and DHW side - boiler cyclically moves the 3-way valve on heating and DHW sides, and pump is continuously powered
		<i>Remark: Auxiliary maintenance functions stay active for about 15 minutes, then the parameter is automatically set back to 0. To stop the function manually, set the value to 0 or quit the Technical Menu.</i>
08	0...2 (1)	Primary circuit working temperatures during DHW demand
	0	dynamics - Do not use in this type of boiler <i>(only for models with flow meter instead of flow switch)</i>
	1	fixed - burner OFF at 75°C and burner ON at 65°C
	2	linked to DHW SET: Burner OFF when DHW temperature + 3 ° C and burner ON when DHW temperature + 2 ° C
12	0...2 (0)	Chimney-sweeper" function: burner ignition, not modulated, to allow the combustion check. For deeper details see paragraph "Combustion test" on page 37.
	0	burner off - normal boiler work <i>(remember to reset this parameter to value 0)</i>
	1	burner ignition at maximum output
	2	burner ignition at minimum output
		<i>Remark: During this phase, the delay between burner ignitions is zero, so if flow temperature is close to maximum, frequent re-ignitions of the burner could take place.</i>
17	20...80	TA2 input setting (flow temperature during a CH request from the Secondary Room Thermostat only) <i>The boiler can manage a secondary room thermostat installed in a zone that must be heated with a different typology compared to the one where the primary room thermostat (or the original Remote Control) is installed. It's possible to foresee (with suitable hydraulic system solutions to distribute the heating to the various zones) a zone with a low temperature heating system (e.g. the primary one, controlled by the primary room thermostat or the original Remote Control) and one with radiators (controlled by the room thermostat TA2). The advantage of this management is that, when only the low temperature system requires heating, the boiler can work in low temperature and therefore condensing, with all the consequent advantages. Please note that the adjustment range is unique and it's extended to both the temperature typologies but, being a technical parameter, there's no possibility for the user to adjust (wrongly) the system flow temperature of the zone managed by TA2. Of course, the user will be able to adjust the room temperature of the secondary zone, by acting on TA2 itself.</i>
22	0; 5...120 (0)	Enabling of Safety Thermostat on floor plant (on AUX input - see also parameter 46) and delay of its operating <i>Remark: avoid selecting values outside of the range described and correct if necessary.</i>
	0	Disabled - the component is not connected to AUX input
	5...120	Minutes of delay between the thermostat activation (open contact) and boiler block. <i>If the thermostat deactivates, the time count resets.</i>

Parameter	Adj. range (fact. set.) and values	Description
33	0...3 (0)	Pump head modulation on Heating demand
	0	Modulation disabled - Pump is always operating at maximum power
	1	Modulation with fixed ΔT - once chosen ΔT with Parameter 34, pump increase or decrease its power in order to keep ΔT as much stable as it can, no matter which Heating demand is present (TA1 or TA2).
	2	Modulation with dynamic ΔT - Once chosen ΔT with Parameter 34, pump increase or decrease its power in order to keep ΔT as much stable as it can during high Temperature demand. If a low temperature demand is present, pump is working at the same way, but its ΔT target is now half of Par 34.
	3	Modulation based on boiler power output - Pump Power is proportional to Boiler Power thanks to optimized algorithm on main PCB.
34	0...3 (0)	ΔT setting for Pump modulating (<i>only if par. 33 is not 0</i>)
	0	$\Delta T = 20^{\circ}\text{C}$
	1	$\Delta T = 15^{\circ}\text{C}$
	2	$\Delta T = 10^{\circ}\text{C}$
	3	$\Delta T = 5^{\circ}\text{C}$
		Remark: When chosen Modulation with fixed ΔT (param. 33=1), it is advised to select 0 or 1 with High Temperature plants and 2 or 3 with low temperature ones. In the case of mixed plant (high and low temperature), Modulation with dynamic ΔT (param. 33=2) is advised because chosen value on Par 34 is used for high temperature demand and half value (param. 34/2) is dynamically used for low temperature demand.
35	65...99 (mod. 25: 88) (mod. 30: 88)	Maximum power of modulating pump. It is recommended not to change factory setting. While minimum pump power is fixed at 65% of the nominal maximum, the maximum pump power can be reduced to solve particular installation (eg. plant noise), provided that the pump modulation is enabled. In fact, if the modulation is disabled (par. 33=0) this parameter is irrelevant.
36	0...4 (2)	Selection of the type of system pressure detection device
	0	ON-OFF pressure switch (<i>for information only - not used on this model</i>)
	1...4	Analog transducer - The boiler reads the transducer's analog signal and commands the automatic filling system to ON-OFF pressures according to the value: 1: 0.4 bar - 0.7 bar; 2 (factory setting): 0.5 bar - 1.0 bar; 3: 0.8 bar - 1.2 bar; 4: 0.9 bar - 1.4 bar
37	0; 1...10 (4)	Enabling and timing of the system's automatic filling
	0	Disabled - for other models without automatic filling system
	1...10	Filling timeout (minutes) after which, if the system pressure has not returned to the nominal value: boiler operation is blocked; the filling is aborted; alarm E19 is generated

Parameter	Adj. range (fact. set.) and values	Description
46	0...2 (0)	AUX input configuration - the AUX input (see "Electrical diagram" on page 54) can be set according to its use, to affect the boiler behaviour.
	0	Safety thermostat of Floor plant - When thermostat opens (open circuit), boiler blocks and shows a specific alarm. Both this parameter and no. 22 are factory set to 0 so, practically, AUX input is ignored.
	1	DHW Storage tank thermostat - Don't use because this function is not allowed on this boiler. <i>Information purpose only: in models with DHW storage, with closed circuit it forces the storage preparation (heating).</i>
	2	Room Thermostat 3 - with closed circuit, this contact activates heating demand at the same temperature of TA1 or Remote control.
49	0...20 (0)	Chooses the type of combustion calibration. <i>Remark: avoid selecting values outside of the range described and correct if necessary.</i>
	0	Manual (CO ₂ adjustment)
	5	Automatic (combustion system preset)

Combustion test

(i) if **burner and exchanger cleaning** is foreseen, carry it out before testing the combustion (see "Combustion group cleaning and check" on page 32).

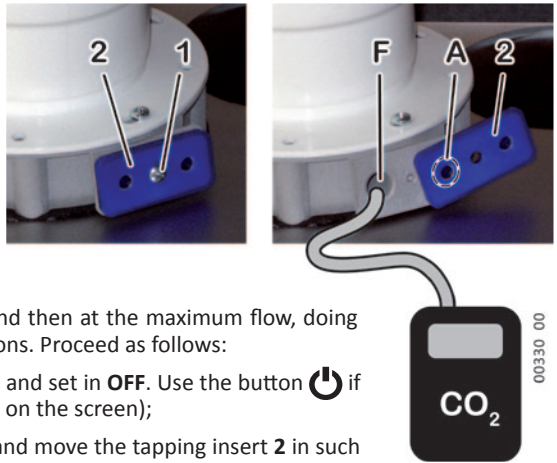

To perform the test you need a **flue analyser, correctly calibrated** (in the condensing boiler, the precision and the correctness of the measures is particularly important). Then, through a suitable function on the panel, we ignite the burner, first with a reduced flow and then at the maximum flow, doing the measure and adjustments in both conditions. Proceed as follows:

1. the boiler should be electrically powered and set in **OFF**. Use the button  if necessary (only **OFF** has to be displayed on the screen);
2. on the flue flange, unscrew the screw **1** and move the tapping insert **2** in such a way to tap the intake plug **A** only; insert the analyser probe in the flue plug **F**, taking care of the seal of the connection;

Remark: The sensor placed at the top of the probe must be placed as possible in the centre of the flow outlet: we advise you to insert well the probe and so to extract it of 3 cm. Insert the probe so that the protection bow of the sensor, placed at the top, is transversal (the flow must pass through it and directly touch the sensor).

3. set the boiler in a status different from **OFF** (e.g. in Winter mode);

- generate a heating request by fully opening a DHW faucet (depending on the boiler's work capability) or, if not possible, by activating the room thermostat.

(i) Be sure that the heat produced by the boiler can be eliminated by the heating system (through the radiators and/or radiant panels/floor systems) or by the water.

- activate the boiler to its **minimum, not modulated power input (Qmin)**, by entering the technician menu and setting the parameter **12** to value **2** (see also "PCB parameters settings (technician menu)" on page 33);
- Wait for the boiler to stabilize (about 5 minutes) then check, referring to the table, that the measured CO₂ value at **Qmin** is within the allowed range;

Mod.	Heat input	Natural gas G20		Commercial Propane G31		Air/Propane G230	
		CO ₂ at Qnw/Qn* and ignition (%)	CO ₂ at Qmin (%)	CO ₂ at Qnw/Qn* and ignition (%)	CO ₂ at Qmin (%)	CO ₂ at Qnw/Qn* and ignition (%)	CO ₂ at Qmin (%)
25	Nominal value	9.2	8.5	10.3	10.1	10.4	10.3
	Allowed range	8.2...9.7	8.0...9.0	9.5...11.0	9.0...11.0	9.5...11.0	9.0...11.0
35	Nominal value	9.2	8.5	10.2	10.1	10.1	10.0
	Allowed range	8.2...9.7	8.0...9.0	9.5...11.0	9.0...11.0	9.5...11.0	9.0...11.0

- don't quit the technical menu and activate the boiler to its **maximum, not modulated power input (Qnw or Qn *)**, changing the value of the parameter **12** to **1**, wait for the boiler to stabilize and check, referring to the table, that the measured CO₂ value at **Qnw/Qn*** is within the allowed range; * depending on the type of heat request, to DHW [Qnw] or CH [max set power input]
- if one or more CO₂ values was outside allowed ranges, carry out the MANUal combustion calibration (see "Combustion calibration" on page 40);
 - if the manual calibration doesn't allow to adjust the CO₂ to normal values, carry out an AUTOmatic calibration (remove the analyser during this operation) and then do a manual calibration again, measuring and adjusting the CO₂. If the problem persists, a fault in some component of the combustion system should be assumed.
- quit the technical menu and set the boiler to **OFF** mode;



IMPORTANT: at the end of the check or the adjustments, it is INDISPENSABLE:

- close the flue plugs used, by restoring the tapping insert **2** and the screw **1**, caring that the plastic surface of the flange is not damaged or worn;
- check the correct flue system tightness, especially the tightness of the tapping insert **2**.

CH Power Input adjustment tables

(i) The boiler is factory set to work in CH mode (modulating) up to an optimal value *Qrisc* which satisfies most cases. It is however certified to operate, in CH mode, **up to the Maximum Nominal Power Input Qn**. **Do NOT set the Parameter 04 to values above Qn** (by doing so, you would violate the certification).

Remark: The Power Input in DHW mode **Qnw** is listed in "Technical data" on page 51.

City Top 25 K - G20	HEAT INPUT	
	kW	Value of par. 4
	MIN. 1.6	00 (<i>Qmin</i>)
	2.4	10
	3.3	20
	6.1	30
	11.6	40
	17.4	50* (<i>Qrisc</i>)
	21.1	60
	23.8	70
MAX. 25.0	72** (<i>Qn</i>)	
FORBIDDEN	73 → 99	

City Top 25 K - G31 - G230	HEAT INPUT	
	kW	Value of par. 4
	MIN. 2.5	00 (<i>Qmin</i>)
	7.0	10
	10.0	20
	13.0	30
	16.0	40
	17.4	50* (<i>Qrisc</i>)
	21.0	60
	MAX. 24.3	65** (<i>Qn</i>)
FORBIDDEN	66 → 99	

City Top 35 K - G20	HEAT INPUT	
	kW	Value of par. 4
	MIN. 1.6	00 (<i>Qmin</i>)
	2.4	10
	3.3	20
	6.1	30
	11.6	40
	17.6	50
	20.8	60* (<i>Qrisc</i>)
	23.8	70
27.5	80	
30.9	90	
33.0	95** (<i>Qn</i>)	
FORBIDDEN	95 → 99	

City Top 35 K - G31 - G230	HEAT INPUT	
	kW	Value of par. 4
	MIN. 2.5	00 (<i>Qmin</i>)
	5.5	10
	9.0	20
	14.0	30
	16.0	40
	18.0	50
	20.8	60* (<i>Qrisc</i>)
	23.5	70
25.5	80	
27.5	90	
32.5	95** (<i>Qn</i>)	
FORBIDDEN	95 → 99	

* *Qrisc* = Factory setting of the Maximum Power Input in CH mode

** *Qn* = Maximum allowed Nominal Power Input in CH mode

Max heating power adjustment

The maximum heating power output must be set in accordance with the system requirements (stated in the project) by using the parameter **04** (see page 34) with reference to the "CH Power Input adjustment tables" on page 38. The boiler is factory preset with a standard value, highlighted in the relevant table.

1. Get information about the maximum heating power requirement of the heating system (reported on the project documentation of the system itself);
2. ensure that there are NOT domestic hot water requests (no open taps) and that the heat produced by the boiler can be drained by the heating system;
3. enter the technician menu (see "PCB parameters settings (technician menu)" on page 33), select the parameter **04** and get ready to change its value. The burner ignites;
4. set the parameter **04** to the value that corresponds to the required power input (refer to the "CH Power Input adjustment tables" on page 38); **do NOT set the parameter 04 to values above the factory setting.**
5. To switch the burner off, quit the technician menu (see also "PCB parameters settings (technician menu)" on page 33). The boiler switches to OFF mode.

The MAX power for the heating system is adjusted now.

Combustion calibration



Boiler is able to self-calibrate combustion in order to obtain correct CO₂ values on 3 different boiler power (minimum, average, maximum); moreover boiler keeps on checking combustion and makes little variations for always getting as better combustion as it can.

Boiler Calibration can be activated by a particular buttons sequences (know by the Technician) and it has 2 following options depending on the parameter 49 (see page 37):

- **AUTOMATIC:** this calibration is made during boiler production; on the field it should not be done **unless components linked to combustion have been replaced** (main PCB, Gas Valve, Fan, Primary exchanger, Burner, Electrode...). At the end of this procedure it is not allowed any change at values stored but boiler can work property with correct combustion values (even if they have to be checked with relevant instruments)



During Combustion Calibration, flues tester should not be used because during this procedure, boiler can produce more than CO₂ needed and test result, in this condition, could not be accurate and truthfulness. **Combustion check with flues tester must be done after Calibration and not during it.**

- **MANUAL:** this calibration checks again the "Automatic calibration" done previously in production and allow the technician to modify a bit the results: +o- 3 steps where CO₂ % is changing about +o-0.6%; this means that every step changes +o-0.2% CO₂). Manual Calibration should be used when technician would like to make a more accurate calibration.
- ▶ Be sure that Parameter 49 is set to Combustion Calibration needed (AUTOMATIC or MANUAL)
 - ▶ activate the Combustion Calibration with relevant buttons sequences (known by Technician);
 - ▶ the display shows the writing **MANU** (or **AUTO** if the automatic calibration is deemed necessary);
- Remark: in any moment, the calibration can be stopped by pressing the button , but the operation must be restarted and carried out completely in order to store the reference values in the system.*
- ▶ once the ignition phase is finished, the system sweeps the three characteristic points: minimum, ignition and maximum, and displaying, respectively, **LO**, **ME** and **HI**.
 - ▶ afterwards, in case of **MANUal** calibration, the CO₂ values can be adjusted:
 - select one of the phases **LO**, **ME** or **HI** by the buttons **+ .III** and **- .III** and wait for the stabilization of the CO₂ value on the analyser;
 - adjust the CO₂ value, if necessary, by the buttons **+ F** and **- F**;
 - proceed in the same way for the other two phases (eventually exclude the **ME**).
 - ▶ Store the set by keeping the button  pressed for at least 2 seconds.
 - ▶ If the value of the Parameter 49 has been modified to carry out the AUTO calibration, restore it to factory setting (see page 37).

Accessing the main board

The main PCB has no hardware adjustment devices onboard, so no access to it is required, except in case of cabling check or replacement of the board itself. Proceed as follows:



Cut off the electrical supply to the boiler. Restore the supply after having closed the control panel rear cover.

- ▶ unscrew the screws **1** and release the latches **2**;
- ▶ remove the back cover of the control panel.



An incorrect or not complete closure of the electronic box voids the IP grade of protection of the appliance. Ensure that all closing items are correctly used and that all cables pass through the suitable slots. If one or more latches **2** should break, please use holes **3** with suitable screws (similar to the standard ones **1**).



Main board replacement

Carefully follow the instructions included in the spare board kit.

Board configuration codes

Model	Gas G20 (1)	Conv. to G31 (2)	Conv. to G230 (2)
City Top 25 K	10710	11710	12710
City Top 35 K	10610	11610	12610

- (1) Factory preset; code written on the sticker on the electronic box
- (2) Code that will appear on the display (for some seconds at the moment of the electrical supply) if the Parameter 01 has been changed because of gas conversion.

Gas conversion



ATTENTION: the operations described below must be carried out only by qualified personnel.

This boiler is designed and prepared to be supplied with Natural Gas G20 (Methane). It can be set, just by means of electronic settings, but **always by a qualified technician, to operate with Commercial Propane G31 or Air/Propane G230, for which it is absolutely necessary to install a pressure reducer upstream the boiler.**



Using Propane gas G31, it is absolutely necessary to install a pressure reducer upstream the boiler. Failure to do this, the gas valve of the boiler will get damaged. The inlet gas pressure must be compliant with the one specified in "Technical data" on page 51.

1. the boiler should be electrically powered and set in a mode different than **OFF**. Use the button  if necessary;
2. set the parameter **01** (see "PCB parameters settings (technician menu)" on page 33) on the required gas kind the boiler is required to work with:
 - **0 = Natural gas (G20),**
 - **1 = Propane (G31)**
 - **2 = Air/Propane (G230)**
3. ensure that the inlet gas pressure complies with the required nominal pressure (see "Technical data" on page 51) and that the gas flow is sufficient to guarantee the appliance correct work with burner ON;
4. we suggest to **clean the burner and exchanger** as described in the paragraph "Combustion group cleaning and check" on page 32 (**except** for the case of first ignition, new burner).
5. carry out the **AUTOMATIC combustion calibration** - see paragraph "Combustion calibration" on page 40 ;

6. carry out the **combustion test** - see paragraph "Combustion test" on page 37 ;
7. apply the label indicating the type of gas (provided with the kit) in the area provided on the "WARNING" plate inside the boiler; besides, write down the new configuration code of the main board (see table "Board configuration codes" on page 41)



In the case of liquid gas fuel, it is important that **the boiler be exclusively fuelled with commercial Propane G31** and not with Butane G30. For this reason, we recommend that **the supplier of the fuel be informed**, for example, **by applying a suitable warning on the gas tank** or in its immediate vicinity, **so that it is visible** to the employee at the time it is being filled.

Draining the heating system

When it is necessary to drain the heating system, proceed as described here below:

- ▶ **Cut the electrical supply to the boiler** (otherwise, the automatic filling system activates);
- ▶ Connect a rubber pipe to the draining tap terminal **1** ;
- ▶ put the other end of the pipe in a suitable drain or sink;
- ▶ open the draining tap by turning the nut **2** counterclockwise, using a suitable spanner;
- ▶ when the pressure is COMPLETELY drained, it's possible to open the radiators venting valves, to allow the air inlet. The complete system drain is possible only draining the liquid from the lowest point of the system itself.

Remark: *The complete system draining can be achieved only by draining the system from its lowest point.*

- ▶ when everything is over, close taps (turning the nut **2** clockwise) and air vents.



Don't tighten excessively the draining tap.

In the primary exchanger a certain quantity of water of the heating system remains. If you want to remove the boiler from the wall, we advice you to close with plugs the hydraulic inlet/outlet heating system connections.



Pump settings

The circulating pump is already set by the factory for all normal boiler applications. It can be adjusted, by means of suitable parameters (see page 36) to optimise the system operation or reduce any noise caused by a too fast circulation. The head curve is shown on page 15.

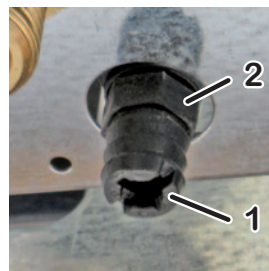

Alarms - boiler block

Following a malfunction, the boiler can lockout and show a particular signal, **RESET** or **SERVICE** on the display, with an alarm code "E...".







In the following table, all the alarm signals are listed, their most probable causes and the suggested solutions. Generally:









- **RESET** identifies those **alarms the user can restore** by pressing the **RESET** button. It normally **blinks**, but after 5 reset actions in 24 hours the action on the **RESET** button has no more effect. *To have 5 further reset possibilities, it's possible to switch off the electrical supply to the boiler for 30 seconds, by using the purposed external switch, even if this work-around won't solve the problem and it will be necessary to call the Service Centre;*



- **SERVICE** identifies those **alarms the user can not restore**, as they are generated by the diagnostic system when a component has been detected as faulty. *The user is allowed to switch off the electrical supply to the boiler for 30 seconds, by using the purposed external switch, but should the alarm happen again, it will be necessary to call the Service Centre.*



















Operations accompanied by the symbol  are always reserved to the Technician. Operations with grey background are reserved to the Technician.









Signal	Probable causes	Suggested solutions
RESET E01	Boiler just installed (air mixed to gas).	<p>Retry the ignition several times: use the RESET button.</p> <p><i>When the 5 reset possibilities are over, to have 5 more, it's possible to switch off the electrical supply to the boiler for 30 seconds, by using the purposed external switch.</i></p>
	The flame has extinguished or it did not ignite	<p>Restore the boiler function by using the RESET button.</p> <p> In case of frequent blocks, verify the correct combustion, the good state and the cleaning of the burner.</p>
	 Incorrect combustion / flame detachment from the burner	<p>Check that the Intake/Outlet Ducts and the respective terminals are clean and in good condition, and that there are no leaks in them. During the installation, respect the regulation prescriptions, the slopes and the lengths (see "Flue systems" on page 23).</p> <p><i>Note for the TECHNICIAN: The burner flame is not detected by the control electronics because it has not turned on or it has suddenly turned off, or it has detached from the burner, because of an incorrect combustion. This can be due, in example, to combustion product reflow into intake duct, leaks in intake/outlet ducts or errors in sizing of ducts (ducts length out of the allowed range, and/or wrong use of the reducer on boiler's outlet).</i></p>
 Condensate drain problem	<p>Verify and restore the correct condensate drain.</p> <p> Warning! DO NOT open the combustion assembly before having cleared the drain and removed the condensate accumulated in the combustion chamber. <i>This alarm is caused by the condensate that, after having partially filled the combustion chamber, reaches the detection electrode and inhibits the detection of the flame ionisation.</i></p> <p>Then, check the combustion and verify that the burner is clean and in good conditions.</p>	
RESET E02	the boiler has overheated and the Safety Thermostat has triggered	<p>Restore the boiler function by using the RESET button. If necessary, wait at least 20-30 minutes (to make the boiler cool) and try again. If the lockout persists or reappears, call the Service Centre.</p> <p> Verify the safety thermostat functionality. Detect the causes of the overheating, e.g. an insufficient circulation in the primary circuit; max gas pressure out of the limits or maximum heating power excessive for the heating system size.</p>
SERVICE E03 	The flue overheat thermal fuse has triggered (flue on boiler outlet too hot)	<p>Solve the problem that caused the overheating of the flue, then replace the flue thermal fuse.</p> <p><i>Note for the TECHNICIAN: the flue thermal fuse preserves the flue ducts (that are made with Polypropylene, a material suitable to the condensate acidity) from the high temperatures, that could lead to their fusion or deformation. The triggering of this device consists in its blowing and therefore it must be replaced.</i></p>
RESET E04 	Combustion check anomaly. Gas valve is supplied without flame presence.	<p>User: Try only one boiler reset by using the RESET button.</p> <p>If the lockout persists or reappears, call the Service Centre for required procedure</p>

Signal	Probable causes	Suggested solutions
SERVICE E05 	Failure to the system flow temperature probe.	Check the cabling of the system flow temperature probe. Replacement of the system flow temperature probe.
SERVICE E06 	Failure to the DHW temperature probe.	Check the cabling of the DHW temperature probe. Replacement of the DHW temperature probe.
SERVICE E07 	Max number of alarms/blocks, of any kind, reached.	Boiler has blocked and has been reset many times. This proves that the boiler has a problem, so call the Service Centre. User: To attempt an interim restore, disconnect the electrical supply to the boiler by operating the suitable external bipolar switch, then connect it again after a few minutes.
SERVICE E08 	Max number of no-flame detection events has been reached.	Flame detection signal has been lost more times in a row. It could be due to anomalies to combustion, flame detection system, or to flue system tightness with fumes returning in air inlet. User: Try a boiler reset by using the RESET button. If the lockout persists or reappears, call the Service Centre.
SERVICE E09	Periodical Service maintenance	Call Service Technician for planned maintenance operations. <i>Pushing RESET, User can cancel this for 3 times. After that the signal remain on display. Even with this signal present, boiler is still working properly.</i>
RESET E10	Insufficient system pressure and wrong setting of parameter 37 (and 36)	 Check that parameters 36 and 37 are correctly set (see "Main boiler parameters (PC)" on page 34). Therefore, during reactivation, it's normal that an automatic filling cycle starts (see "E18"). <i>Remark: Consider that the pressure, in normal conditions, should not decrease with the progress of the time. If this happens, there is probably a loss in the heating system. Sometimes the loss is so small that it doesn't leave evident signs, but with the progress of the time it can cause the decreasing of the pressure. Also the opening of the manual venting taps of radiators (intentional or unintentional) makes the pressure decrease. Check that this doesn't happen.</i>
SERVICE E13 	Gas modulator not connected.	Check the cabling of the gas valve's modulation command. Gas valve electrical circuit failure. Check/replace.
SERVICE E15 	Failure to the heating system return temperature probe.	Check the cabling of the system return temperature probe. Replacement of the system return temperature probe.
RESET E16 	Fan failure. The burner fan is stopped or rotates at an incorrect speed.	User: Try a boiler reset by using the RESET button. If the lockout persists or reappears, call the Service Centre. Check the burner fan functionality. Replace it if necessary.
E17 	Pushbutton failure. The electronic has detected the actuation of a pushbutton for more than 30 seconds.	User: check for jammed pushbuttons that remain pressed. Disconnect the electrical supply to the boiler by operating the suitable external bipolar switch, then connect it again after a few minutes. Remove the main PCB and clean, using suitable products, the rubber keyboard and pushbuttons' contact pads both on buttons and on the PCB. Replace damaged parts if necessary.

Signal	Probable causes	Suggested solutions
RESET E18	Automatic filling in progress	The CH system water pressure was insufficient for the normal functioning so the boiler started the automatic water filling in the CH system. Once the right pressure is achieved, the error code automatically disappears and the boiler restart the normal function.
SERVICE E19	Automatic filling in not completed after 4 minutes.	<p>An automatic water filling cycle has started (see "E18") but the correct pressure has not been reached after 4 minutes.</p> <ul style="list-style-type: none"> inlet water pressure from the net is not sufficient (see "Technical data" on page 51); inlet water cannot enter the boiler for likely closed tap installed in the inlet way (in this case, hot water does not flow). <p>Try to restart the boiler by powering the boiler off for 30 second and the power that on again from the bipolar switch.</p> <p><i>It is possible, temporarily, to manually restore the pressure using the screw of the tap accessible from the bottom of the boiler (see "Preliminary operations" on page 9).</i></p> <p> Filling in valve is blocked/broken/or it is not electrically supplied • Inlet filters are clogged • Big quantity of scale in the water • Considerable water leak in the CH system.</p>
SERVICE E21	Low system pressure <i>(all the allowed filling attempts have been spent)</i>	<p>The boiler has detected a low system pressure, but it has already filled the system (see "E18") for three times within the latest 24 hours. Likely there is a water leak in the CH system</p> <p>Try to restart the boiler by powering the boiler off for 30 second and then on again from the bipolar switch. <i>During the power-up, an automatic filling in cycle could start (see "E18").</i></p> <p><i>Note: it is possible to experience this alarm code during the first filling in when the boiler is just installed due to bleeding of air from the system. For this reason, at the first time the boiler get electrically supplied, the number of fillings allowed before showing the error code are 5 and not 3 for the first 24 hours after the installation.</i></p> <p><i>Remark: Consider that the pressure, in normal conditions, should not decrease with the progress of the time. If this happens, there is probably a loss in the heating system. Sometimes the loss is so small that it doesn't leave evident signs, but with the progress of the time it can cause the decreasing of the pressure. Also the opening of the manual venting taps of radiators (intentional or unintentional) makes the pressure decrease. Check that this doesn't happen.</i></p> <p> Leak in the heating system.</p>
SERVICE E22	PCB Software Error.	Call Service Centre for required procedure.
SERVICE E23	Inlet electrical frequency not correct (50 Hz ± 1 Hz).	Call Service Centre for checking electric inlet signal.

Signal	Probable causes	Suggested solutions
RESET E24 	Floor heating system safety thermostat triggering: <ul style="list-style-type: none"> ▶ system flow temperature too high; ▶ floor heating system defective, faulty or malfunctioning. 	The floor heating system and the floor cladding can be damaged by temperature shocks, so a good quality system includes one or more safety thermostats that, if necessary, trigger and lock the boiler. Try a boiler reset by using the RESET button (eventually wait for a period that allows to cool the system and restore the thermostat). If the lockout persists or reappears, call the Service Centre <i>Remark: This alarm is in relationship with parameters 22 and 46 (paragraph "Main boiler parameters (PC)" on page 34. When this alarm is active, the hot water production is locked too.</i>
		 If any floor heating system was installed , check the correct setting of parameter 22 (see page 35). If the floor heating system is installed , check the system flow temperatures on the boiler and on the low temperature system kits (if installed). Replace the faulty or out-of-tolerance thermostats. Check the correct positioning of the thermostats on the system (see "Floor heating system" on page 16). Consider if the delay on the thermostat's triggering is too low and eventually, carefully, adjust it by increasing the value of parameter 22.
SERVICE E25 	Automatic calibration needed.	Call Service Centre for required Combustion Calibration. See also "Combustion calibration" on page 40.
SERVICE E26 	Gas valve remains closed.	Call Service Centre for required procedure.
SERVICE E29 	Flues system completely or partially closed.	Call Service Centre for checking cleanliness of flues system, its capacity of aspiration/discharging and Gas inlet pressure.
SERVICE E31 	Remote control* not working <i>Data exchanged between the boiler and the Remote Control don't comply with the expected protocol.</i> <i>* This applies to Remote Control optional kit only, and not to third parties chrono-thermostats</i>	User: Disconnect the electrical supply to the boiler for at least 30 seconds, by operating the suitable external bipolar switch, then connect it again and ensure that the Summer mode is selected by using the button  . If the lockout persists or reappears, call the Service Centre. Problems on the optional Remote Control connection link (passing close to supply cables or other electromagnetic field sources; connection failure; cable length over 50 meters).
RESET E35	Unexpected flame the control electronic has detected the flame on the burner when this one should be off	Wait for the boiler automatic reset (5 minutes) or reset it manually by using the RESET button. If the lockout persists or reappears, call the Service Centre.  Detect eventual malfunctioning of the gas valve (that does not stop fully the gas flow, so the burner remains ignited) or of the electronics, flame detection section (that detects the flame presence even if it's absent).

Signal	Probable causes	Suggested solutions
SERVICE E38 	<p>Failure to the outdoor temperature probe (optional).</p> <p>The outdoor temperature probe, that was recognized and working, now results faulty.</p>	<p>User: Call the Service Centre.</p> <p><i>The boiler now works either in heating and in hot water, like as the external boiler had never been installed, so the heating system temperature is set directly and not as a function of the outdoor temperature. The alarm is displayed to inform that the accessory is no more efficient (consider that, on a first analysis, the boiler seems to work perfectly). Important: if the boiler is turned off and then on again, it's possible** that the alarm is no more displayed, even though the problem persists.</i></p> <p>Check the cabling of the outdoor temperature probe.</p> <p>Replacement of the outdoor temperature probe.</p> <p><i>** The alarm shows again only if the resistance of the probe is out of tolerance or in short-circuit. On the contrary, if the probe or the relevant cabling is interrupted, when the electrical supply is restored the boiler will consider the external probe absent and, in Winter mode, it will work in normal mode (temperature shifting disabled).</i></p>
SERVICE E39 	<p>Suspected freezing</p> <p>After a power failure, the boiler detected temperatures at the Heating and DHW probes equal to, or less than, 0°C when power was restored</p>	<p>The display shows the alarm code 39 while the boiler inhibits the ignition of the burner and activates the circulator, forcing water to circulate in the hydraulic circuits.</p> <p>If, during this time, the temperatures measured by the probes rise above +1°C, the alarm is reset and the boiler returns to the normal operation.</p> <p>Otherwise, the alarm will persist and you should suspect that water has frozen at one or more points of the hydraulic circuit of the boiler and/or system (with possible damage to the frozen parts). If the alarm persists, call a qualified technician.</p> <p> Find/replace the parts damaged by the freezing.</p>
RESET E43 	<p>Return overheat. About 90°C felt by CH return probe.</p>	<p>User: Try only one boiler reset by using the RESET button.</p> <p>If the lockout persists or reappears, call the Service Centre for required procedure</p>
SERVICE E44 	<p>Poor plant Circulation. Flow temperature increased too sharply.</p>	<p>Call Service Centre for required procedure.</p>
SERVICE E45 	<p>Return and flow probes inverted. Check CH probes (Flow and Return).</p>	<p>Call Service Centre for required procedure.</p>
SERVICE E47 	<p>Max number of no-flame detection events has been reached, mainly during the combustion internal check cycle. Refer to Alarm E08 for the probable causes and for the boiler reset actions suggested.</p>	
SERVICE E48 	<p>Max number of no-flame detection events has been reached, mainly after the ignition for a DHW request. Refer to Alarm E08 for the probable causes and for the boiler reset actions suggested.</p>	
SERVICE E49 	<p>Max number of no-flame detection events has been reached, mainly after the ignition for a CH request. Refer to Alarm E08 for the probable causes and for the boiler reset actions suggested.</p>	

Signal	Probable causes	Suggested solutions
SERVICE E50 	Minimum Inlet voltage not correct (Min 195V).	Call Service Centre for checking inlet signal.
SERVICE E78 	Combustion check anomaly. Gas valve current out of range.	Call Service Centre for required procedure.
SERVICE E79 	Combustion check anomaly. Check Fan not finished.	Call Service Centre for required procedure.
SERVICE E88 	Combustion check anomaly. Modulator Gas valve current too high.	Call Service Centre for required procedure.
SERVICE E90 	Combustion check anomaly. Flame detection signal too high for 1 instant.	Call Service Centre for required procedure.
SERVICE E92 	System pressure too high.	Call Service Centre for required procedure.
SERVICE E93 	Combustion check anomaly. Flame detection signal too high for more than 10 sec.	Call Service Centre for required procedure.
SERVICE E99 	PCB generic anomaly	Call Service Centre for required procedure.

Warnings for servicing



All servicing operations and gas conversions **MUST BE CARRIED OUT BY QUALIFIED TECHNICIANS**, in compliance with the norms and laws in force (see an indicative list on page 4). Moreover, **MAINTENANCE** operations must be carried out in compliance with the manufacturer prescriptions and with the laws and rules presently in force, for the parts not mentioned in this handbook; we advice to perform them at least once a year to maintain the boiler's performance.

A careful servicing is always a guarantee of safety and energy saving. Normally, it will be necessary to execute the following operations:

- ▶ Remove any possible oxidization from burners and electrodes;
- ▶ Remove the scale from the exchangers;
- ▶ Cleaning and checking the exchanger, the siphon and all the parts which are in touch with the condense;
- ▶ Check integrity and stability of the insulating coverings in the combustion chamber and proceed eventually to substitution;
- ▶ Check the boiler ignition, switching off and operation;
- ▶ Check the water and gas connections tightness;
- ▶ Check the gas consumption at the minimum and maximum output;
- ▶ Verify that safety devices are correctly working;
- ▶ Verify the correct functioning of control and adjusting devices;
- ▶ Verify periodically the absence of leaks of combustion products to the inner room, the correct functioning and the integrity of the flue outlet ducts and/or devices and of the relevant terminals and accessories;
- ▶ In case of works or servicing of the structures placed near the above mentioned ducts and /or devices and their accessories, switch off the boiler;
- ▶ Do not leave any inflammable tanks and/or substances in the installation room;
- ▶ If the boiler draws directly from the installation room (*type B appliance installed indoor*): Do not clean the room where boiler is installed, while it is working
- ▶ Clean casing with soapy water only. Do not clean casing, other painted or plastic surfaces with thinner.
- ▶ In any case of parts replacement, it is mandatory to use ITALTHERM original spare parts.

ITALTHERM declines any responsibility in case of non-original spare parts utilization.

ErP Data - EU 813/2013

Supplier name: Italtherm Contact details: Italtherm S.p.A. – Via Salvo D'Acquisto – 29010 Pontenure (PC) – Italy		Model(s):		City Top 25 K	City Top 35 K
ErP Data - EU 813/2013		Symbol	Unit	Value	Value
Condensing boiler			Yes/No	YES	YES
Combination heater			Yes/No	YES	YES
B1 boiler			Yes/No	NO	NO
Cogeneration space heater:			Yes/No	NO	NO
Low-temperature (**) boiler			Yes/No	NO	NO
ErP space heating	Rated heat output	P_{rated}	kW	24	32
	Useful heat output at rated heat output and high-temperature regime (*)	P_4	kW	24.1	32.2
	Useful heat output at 30% at rated heat output and low-temperature regime (**)	P_1	kW	8.0	10.6
	Seasonal space heating energy efficiency (GCV)	η_s	%	90	90
	Useful efficiency at rated heat output and high-temperature regime (*) (GCV)	η_{4s}	%	86.6	87.4
	Useful efficiency at 30% of rated heat output and low-temperature regime (**)(GCV)	η_{1s}	%	94.8	95.1
ErP DHW	Declared load profile			XL	XXL
	Water heating energy efficiency (GCV)	η_{wh}	%	86	85
	Daily electricity consumption	Q_{elec}	kWh	0.155	0.167
	Daily fuel consumption	Q_{fuel}	kWh	22.72	28.35
Auxiliary electricity consumption	At full load	el_{max}	kW	0.038	0.050
	At part load	el_{min}	kW	0.018	0.022
	In standby mode	P_{SB}	kW	0.005	0.005
Other items	Standby heat loss	$P_{standby}$	kW	0.064	0.064
	Ignition burner power consumption	P_{ign}	kW	0.000	0.000
	Sound power level, indoors	L_{WA}	dB	53	54
	Emissions of nitrogen oxides	NO_x	mg/kWh	29.2	28.5

(*) High-temperature regime means: 60 °C return temperature at heater inlet and 80 °C feed temperature at heater outlet.
(**) Low temperature means: for condensing boilers 30 °C, for low-temperature boilers 37 °C and for other heaters 50 °C return temperature (at heater inlet).
GCV = Gross Calorific Value (=Hs)

Product fiche - EU 811/2013

Supplier name: Italtherm Contact details: Italtherm S.p.A. – Via Salvo D'Acquisto – 29010 Pontenure (PC) – Italy		Model(s):		City Top 25 K	City Top 35 K
Product fiche - EU 811/2013		Symbol	Unit	Value	Value
Declared load profile DHW				XL	XXL
Seasonal energy efficiency for space heating				A	A
Energy efficiency for water heating				A	A
Rated heat output	P_{rated}	kW		24	32
Annual energy consumption	Q_{HE}	GJ		41	54
Annual electricity consumption	AEC	kWh		34	36
Annual fuel consumption	AFC	GJ		17	22
Seasonal space heating energy efficiency (GCV)	η_s	%		90	90
Water heating energy efficiency (GCV)	η_{wh}	%		86	85
Sound power level, indoors	L_{WA}	dB		53	54

GCV = Gross Calorific Value (=Hs)

Technical data

- Qnw** Maximum heat input in DHW mode (determined by the burner model and the advanced settings)
Qn Maximum allowed heat input in CH mode (see also "CH Power Input adjustment tables" on page 38)
Qrisc Heat input **at factory settings**. The technician is allowed to adjust the heat input in CH, **without exceeding Qn** (see also "CH Power Input adjustment tables" on page 38)
Qa Heat input, at the arithmetic average of the maximum and minimum thermal capacity
Qmin Minimum heat input (both in heating and DHW modes)
 * system return / flow water temperature
NCV Net Calorific Value (=Hi)

Remark: data have been measured with horizontal coaxial flue, length = 1 m

TECHNICAL DATA	U.M.	City Top 25 K			City Top 35 K		
		G20	G31	G230 ¹	G20	G31	G230 ¹

CE certification		0476 CS 1134			0476 CS 1134		
Class		II2HM3P (II2H3P) ²			II2HM3P (II2H3P) ²		
Type		B23 - B23P - B53 - B53P - C13 - C33 - C43 - C53 - C63 ⁽⁰⁾ - C83 - C93					
(0) In C63 configuration, the allowed flue typologies are only the equivalent to the one listed:		C13-C33-C53-C83					
Working temperature range (min÷max)	°C	0 ÷ +60			0 ÷ +60		

(1) = allowed in Italy only (2) = outside Italy

Max heat input in DHW Qnw	kW	25.0	24.3	24.3	34.9	34.0	34.0
Max heat input in CH Qn	kW	25.0	24.3	24.3	33.0	32.5	32.5
Heat input in CH Qrisc	kW	17.4	17.4	17.4	20.8	20.8	20.8
Min heat input Qmin	kW	1.6	2.5	2.5	1.6	2.5	2.5
Max heat output 60°/80°C *	kW	24.1	23.4	23.4	32.2	31.5	31.5
Min heat output 60°/80°C *	kW	1.5	2.4	2.4	1.5	2.3	2.3
Max heat output 30°/50°C *	kW	26.7	25.6	25.6	34.8	34.0	34.0
Min heat output 30°/50°C *	kW	1.7	2.6	2.6	1.7	2.6	2.6
NO _x Class		6	6	6	6	6	6
CO at 0% O ₂ at Qnw	ppm	203.5	216.0	152.0	235.3	226.1	197.4
CO at 0% O ₂ at Qn	ppm	203.5	218.1	152.0	216.2	201.5	190.6
CO ₂ at Qnw	%	9.20	10.40	10.40	9.20	10.30	10.10
CO ₂ at Qn	%	9.20	10.30	10.40	9.20	10.20	10.10
Condense quantity at Qn (30°/50°C *)	l/h	2.6	2.6	2.6	3.7	3.7	3.7
Condense quantity at Qmin (30°/50°C *)	l/h	0.2	0.2	0.2	0.2	0.2	0.2
Condense acidity	pH	2.8	2.8	2.8	2.8	2.8	2.8
Flue temperature, Max.	°C	56.0 60/80° Qn	60.0 60/80° Qn	60.0 60/80° Qn	61.0 60/80° Qn	63.0 60/80° Qn	63.0 60/80° Qn
Flue temperature, Min.	°C	41.0 30/50° Qmin	41.0 30/50° Qmin	41.0 30/50° Qmin	41.0 30/50° Qmin	41.0 30/50° Qmin	41.0 30/50° Qmin
Flue mass flow rate at Qnw (60/80°C *)	kg/h	40.52	39.58	42.70	56.57	55.74	62.49
Flue mass flow rate at Qn (60/80°C *)	kg/h	40.52	39.22	42.70	53.49	53.78	58.87
Flue mass flow rate at Qmin (60/80°C *)	kg/h	2.80	4.15	4.43	2.80	4.18	4.57

EFFICIENCY

Efficiency η _{100%} Qn/Qa (NCV) at 60°/80°C *	%	96.2			97.1		
Efficiency at Qn (NCV) at 30°/50°C *	%	104.4			105.1		
Efficiency at η _{30%} Qn/Qa (NCV) at 30°/50°C *	%	105.3			105.6		

(continua)

TECHNICAL DATA (cont'd)		City Top 25 K			City Top 35 K		
Gas type	U.M.	G20	G31	G230	G20	G31	G230
		HEATING					
Temperature selection range (min÷max) <i>Main heating circuit, normal range / low temp. range</i>	°C	35÷80 / 20÷45					
Temperature selection range (min÷max) <i>Secondary heating circuit</i>	°C	20÷80					
Characteristics of the heating system water (or filling liquid) <i>(* = if aluminium parts are present along the system)</i>	°f pH	5 ÷ 15 °f pH 7.5 ÷ 9.5 (7.5 ÷ 8.5 *)					
Expansion vessel	l	10			10		
Expansion vessel pre-loading pressure	bar	1			1		
System pressure for automatic filling turning ON/OFF <i>(See parameter 36, page 36)</i>	bar	0.5 / 1.0 (±0.2)			0.5 / 1.0 (±0.2)		
		<i>To allow the correct system filling, the pressure of the domestic water should be higher than the ON value of the pressure switch.</i>					
System pressure for system overpressure alarm ON/OFF	bar	3.0 / 2.6 (±0.2)			3.0 / 2.6 (±0.2)		
Max working pressure	bar	3			3		
Max system temperature	°C	90			90		
Anti-freezing function temperature on / off	°C	5 / 30			5 / 30		
HOT WATER							
Flow rate at 25°C temp. rise	l/min	15.5			19.9		
Flow rate at 30°C temp. rise	l/min	12.2			16.4		
Min water flow <i>(for the DHW function activation)</i>	l/min	2.8			2.8		
Min supply pressure <i>(for the DHW function activation)</i>	bar	0.2			0.2		
Max supply pressure	bar	6			6		
Temperature selection range (min÷max)	°C	35÷55			35÷55		
Flue temperature, average (DHW, ΔT 25°C)	°C	48			52		
Flue temperature, average (DHW, ΔT 30°C)	°C	50			54		
ELECTRICAL DATA							
Voltage / frequency (nominal voltage)	V / Hz	220÷240 / 50 (230V)			220÷240 / 50 (230V)		
Power consumption	W	87			110		
Level of protection		IP X5D			IP X5D		
DIMENSIONS							
Width - Height - Depth	mm	see "Dimensions and connections" on page 15					
Weight: net / gross	kg	36.8 / 39.4			36.8 / 39.4		
CONNECTIONS							
Hydraulic and gas connections		see "Dimensions and connections" on page 15					
Flue: types, lengths and diameters		see "Flue systems" on page 23					
Delta P outlet/inlet (fan head loss)	Pa	20 ÷ 150			20 ÷ 150		
GAS SUPPLY PRESSURE							
Nominal pressure	mbar	20	37	20	20	37	20
Inlet pressure (min÷max)	mbar	17 ÷ 25	35÷40	17 ÷ 25	17 ÷ 25	35÷40	17 ÷ 25
GAS CONSUMPTION							
at Qnw	m³/h	2.64		1.99	3.69		2.83
	kg/h		1.88			2.64	
at Qn	m³/h	2.64		1.99	3.49		2.67
	kg/h		1.88			2.52	
at Qmin	m³/h	0.17		0.21	0.17		0.21
	kg/h		0.19			0.19	

Boiler internal components

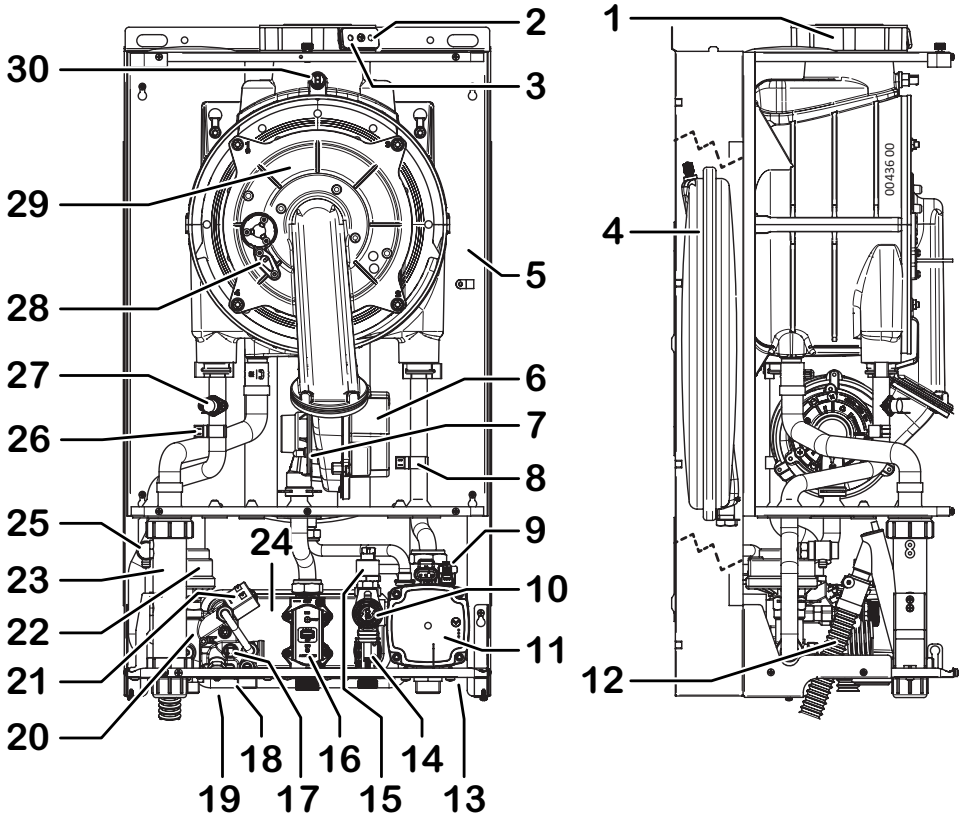

- | | | | |
|----|--|----|--|
| 1 | Flue connection flange | 17 | DHW temperature sensor |
| 2 | Plug for Combustion analysis (air intake) | 18 | System pressure gauge |
| 3 | Plug for Combustion analysis (flue) | 19 | Manual filling cock |
| 4 | Expansion Vessel | 20 | By-pass (in-built in the 3-way valve hydraulic assembly) |
| 5 | Insulated sealed chamber | 21 | System filling electrovalve |
| 6 | Fan | 22 | Motorized 3-way valve |
| 7 | Air/Gas Mixing device | 23 | Siphon for condense outlet |
| 8 | Temperature Sensor on system return | 24 | DHW exchanger |
| 9 | Automatic Venting Device (heating circuit, incorporated in the pump) | 25 | Manual Venting Device (Combustion assembly) |
| 10 | Safety valve 3 bar | 26 | Temperature Sensor, system flow |
| 11 | Pump | 27 | Safety thermostat on system flow |
| 12 | Pipe for condense outlet | 28 | Flame ignition/detection electrode |
| 13 | Drain valve | 29 | Combustion assembly (burner+primary exchanger) |
| 14 | Priority flow switch (with filter) | 30 | Flue overheat fuse |
| 15 | System pressure transducer | | |
| 16 | Gas valve | | |

Electrical diagram

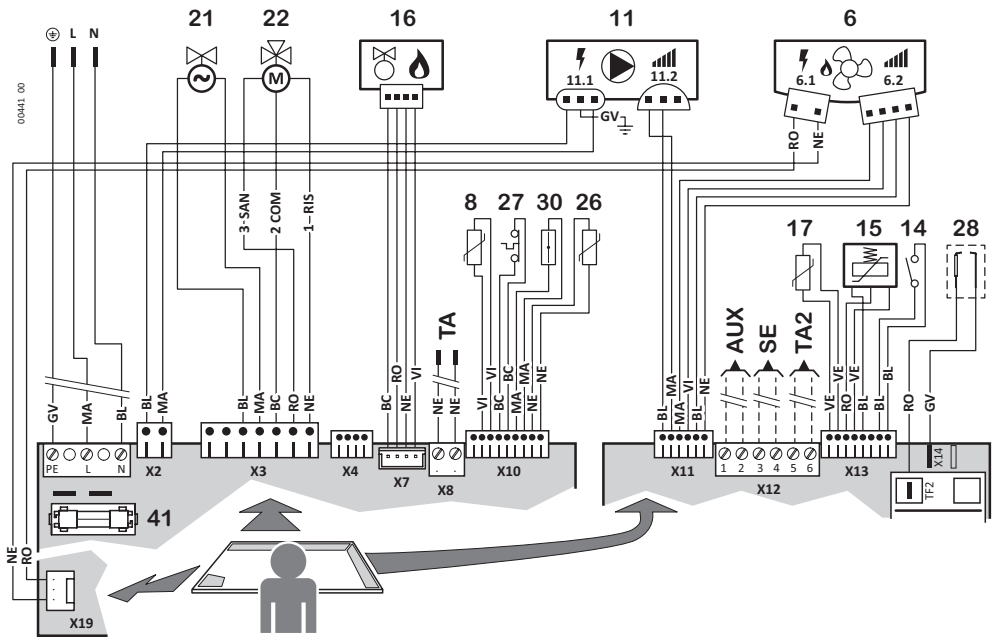

- 6.1 Fan - supply
- 6.2 Fan - speed control
- 8 Temperature Sensor on system return
- 11.1 Pump - supply
- 11.2 Pump - modulation control
- 14 Priority flow switch (with filter) (*)
- 15 System pressure transducer
- 16 Gas valve
- 17 DHW temperature sensor
- 21 System filling electrovalve
- 22 Motorized 3-way valve
- 26 Temperature Sensor, system flow
- 27 Safety thermostat on system flow (*)
- 28 Ignition and flame detection Electrode
- 30 Flue overheat fuse
- 41 Fuse F2A (2A fast)

(*) the contacts of these components are shown in rest conditions (cold condition, no system pressure, no flow)

Optional external devices:

TA Room thermostat: (or Chronothermostat) SELV simple contact. Closed contact = heating request.
or **Remote control** (original accessory only)

SE To optional outdoor temperature sensor

TA2 To optional room thermostat for zones with different temperature range

AUX Input for optional device, configurable with Parameter 46 (see page 37).

Abbreviations: COM Common • NC Normally closed (contact) • NO Normally open (contact)
• HEA Heating (diverting command) • DHW Hot water (diverting command)

Colours: BK Black • BN Brown • BU Blue
• GN Green • RD Red • OG Orange • VT Violet
• WH White • YE Yellow • YG Yellow-Green

Hydraulic diagram

This diagram is for information only. To make boiler hydraulic connection either see "Dimensions and connections" on page 15 and eventually "Positioning and fastening" on page 18.

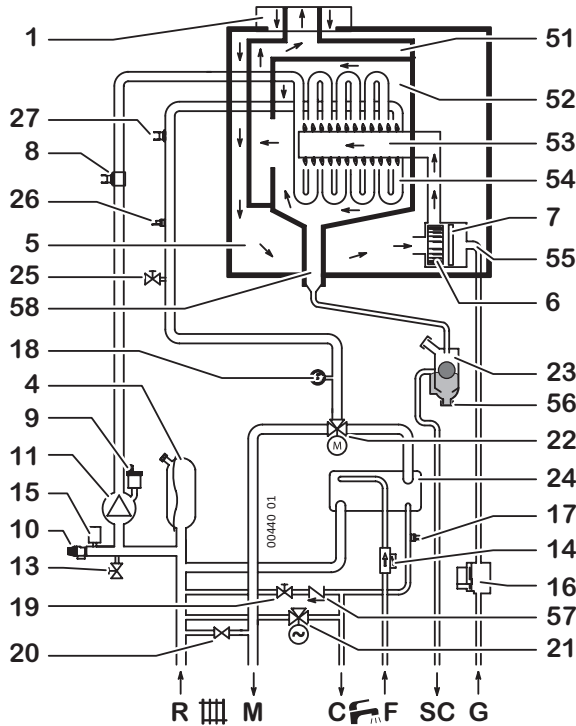

- | | |
|--|--|
| 1 Flue connection flange | 23 Siphon for condensate outlet |
| 4 Expansion Vessel | 24 DHW exchanger |
| 5 Insulated sealed chamber | 25 Manual Venting Device (Combustion assembly) |
| 6 Fan | 26 Temperature Sensor, system flow |
| 7 Air/Gas Mixing device | 27 Safety thermostat on system flow |
| 8 Temperature Sensor on system return | 51 Flue hood |
| 9 Automatic Venting Device (heating circuit, incorporated in the pump) | 52 Combustion chamber |
| 10 Safety valve 3 bar | 53 Burner |
| 11 Pump (including automatic venting device) | 54 Primary exchanger |
| 13 Drain valve | 55 Gas pipe |
| 14 Priority flow switch (with filter) | 56 Tap for condensate siphon cleaning |
| 15 System pressure transducer | 57 Check valve |
| 16 Gas valve | 58 Condensate drain in combustion assembly |
| 17 DHW temperature sensor | |
| 18 System pressure gauge | |
| 19 Manual filling cock | |
| 20 By-pass (in-built in the 3-way valve hydraulic assembly) | |
| 21 System filling electrovalve | |
| 22 Motorized 3-way valve | |
| | R Heating return |
| | M Heating flow |
| | C Hot water outlet |
| | F Cold water inlet |
| | SC Condensate drain |
| | G Gas inlet |



Outdoor Sensor Kit

Installation and setting

The Outdoor Sensor manages automatically the CH flow temperature** as a function of the outdoor temperature, thus avoiding the user to adjust it manually. This function is also named "shifting temperature".

** that's the temperature of the heating elements. Don't mistake it with the room temperature (managed by the room thermostat or by the Remote Control, but not by the boiler) that doesn't depend on the first one.

The installation must be made by a professionally skilled technician following the instructions supplied with the kit. Refer to "Electrical diagram" on page 54 for the links to the Main Board.

After the installation of the Sensor, the buttons **+|||** and **-|||** described in the User section (see page 10) won't adjust directly the CH flow temperature, but the dispersion factor "**kd**" that's the response of the outdoor temperature, detected by the sensor, on the CH flow temperature, as shown in the following graph.

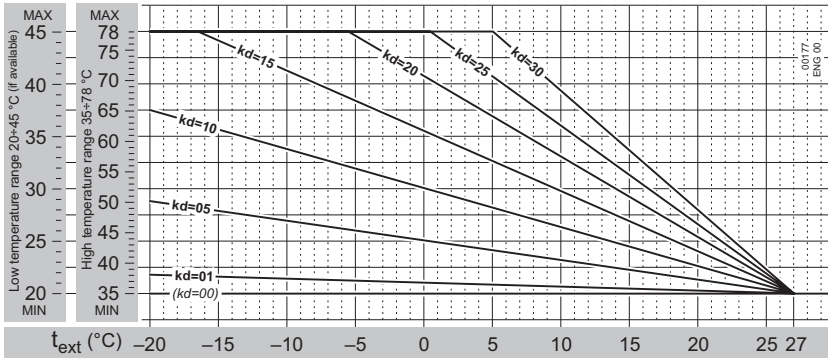

Practically, **kd** value should be adjusted depending on the estimated efficiency of the building's thermal insulation. Its range is from **01** to **30**: use **higher values** when there is a **high thermal dispersion** and therefore a **less efficient insulation** (and vice versa).

(i) Because of the wide buildings typologies, it's impossible to give precise indications on **kd** value to set. **The correct setting must be determined case by case and will have, as a result, an optimal comfort in all the climatic conditions** requiring heating, i.e. a prompt reaching of the room temperature with cold weather and no room overheating during mild periods.

Outdoor Sensor kit and Remote Control

If also the Remote Control Kit is installed, please refer to the relevant instruction handbook for details about the combined working of Outdoor Sensor and Remote Control itself.

Remote Control Kit

This remote control is **more than a simple room thermostat**. Thanks to this, it is possible to **manage the boiler in all its settings** like DHW and CH temperature adjustment, **boiler reset** in case of boiler block, and of course it works as a **room thermostat** both in **manual** and **weekly program** mode. It's powered by the boiler (in safety low voltage), so **it doesn't need batteries**.



(i) Extract the Remote Control from its package. **Keep the relevant user instruction booklet and annex it to this Manual.**



Nor the Remote Control neither the relevant cable coming from the boiler must not, for any reason, be connected to the 230Vac supply mains.



To avoid malfunctions due to electrical noise, the Remote Control connections, as well as all low-voltage connections, should be kept separated from power supply cables, e.g. by enclosing it into separate raceways.

The maximum overall cable length shouldn't exceed 50 m.

1. Cut off electricity from boiler;
2. install the device as described in the **paragraph 1** of the supplied instruction booklet;
3. connect the terminals "**OT**" **nr. 1-2** of the Remote Control to the "TA - Room Thermostat - Remote Control" cable coming out of the boiler, by means of a suitable bipolar terminal. See also "Electrical diagram" on page 54;

Note: *The Remote Control link is not polarized.*

4. power supply the boiler and select the **Summer** mode;
5. check the correct work of the device. The electronics should recognize it automatically.

(i) Hereafter, the boiler should be left on **Summer mode**; the boiler work is managed by the Remote Control, including the **OFF, Summer and Winter modes, and the technical functions (such as several additional functions).**

In case of problems in wirings or in boiler setting, the alarm **E31** will appear. See **E31 alarm** description on page 46.

Appliance disposal



At the end of its life, the product must not be disposed of as solid urban waste but must be sent to a separate collection centre.

Modulating circulating pump - details

The circulating pump is electronically controlled and receives **power supply** and "**PWM**" **speed control signal** over two different connectors. The front cap features a hole with pin to unlock the rotor **2** and, depending on the model, a two-colour status light indicator **1**.



Status indicator

When present, indicator **1** can be:

off - the circulating pump does not receive voltage on the power supply connector: this means that:

- the boiler is set to **OFF** or is not powered
- there is a fault on the **power supply** wiring

flashing green - the circulating pump is powered and correctly receives the input speed control signal (PWM). *N.B.: The flashing is very fast - approx. 12 times per second.*

Note: *This occurs even when, with no heat request, the circulating pump is at a standstill.*

steady green - the circulating pump is powered but it does not receive the speed control signal (PWM). This appliance is provided with PWM control, hence, if the indicator **1** is steady green, it is likely that there is a fault to the PWM signal wiring or the management electronic components.

(i) With no PWM signal (provided that power supply is present) **the circulating pump operates at 100% of its speed regardless of the operating status of the boiler.**

steady red - alarm status. **The circulator is at a standstill.** There are **3 different possible causes** but are all signalled in this way. **Search for the cause following the sequence below:**

- 1 - blocked rotor**, usually, due to a long period of inactivity - try to unlock it as indicated in the following sub-section
- 2 - power supply** present but voltage **too low** (or in any case out of tolerance). Check that the power supply to the connector of the circulating pump is within the values indicated for the boiler (see table "Technical data" on page 51)
- 3 - fault to the internal electronic components of the circulating pump** (replace the circulating pump with an original spare part)

Circulating pump rotor unlocking

(i) **Disconnect the boiler from the power supply** to avoid the activation of the motor during the operation. Discharge also the system pressure, if possible.

- 1.** Insert a 4 mm Phillips screwdriver in the central hole of the cap, fit it in the relevant screwdriver seat on pin **2**, then **push the screwdriver (it must enter by approx. 4-5 mm)**, allowing the pin to engage with the rotor shaft;

Note: *If you do not push, only the pin will turn and the rotor will not be unlocked;*

- 2.** turn the screwdriver (and keep pushing) to unlock and engage the rotor;
- 3.** extract the screwdriver, restore the boiler operating conditions and check that the issue has been solved (indicator **1** green).



www.italtherm.it



ITALTHERM S.p.A. declines any responsibility for eventual printing and/or transcription errors in the present manual. In order to constantly improve its products, the company has the right to change features and data written in the present manual, at any time and without notice.

960000163_03_ENG
20210311